



TEST REPORT

Test Report # 19A-000716-5 Date of Report Issue: March 6, 2019
Date of Sample Received: February 27, 2019 Pages: Page 1 of 27

PRODUCT DESIGNATION: MINI TOOL SET WITH LED LIGHT
BRAND NAME: N/A
MODEL NAME: IT3874
CLIENT: Mid Ocean Brands B.V.
DATE OF ISSUE: March 6, 2019
STANDARD(S): EN 55015:2013+A1:2015, EN 61547:2009

Prepared by: Hangzhou Asiainspection Testing Technology Co.,Ltd.

The EMC testing has been performed on the submitted samples and found in compliance with the council EMC directive 2014/30/EU.

Hangzhou Asiainspection Testing Technology Co.,Ltd.
5th Floor, A2 Building, No. 1213, Huo Ju South Road,
Binjiang District, Hangzhou, China
Tel: +86-571-89997158



TEST REPORT

Test Report # 19A-000716-5 Date of Report Issue: March 6, 2019
 Date of Sample Received: February 27, 2019 Pages: Page 2 of 27

TABLE OF CONTENTS

Description	Page
1. VERIFICATION OF CONFORMITY	3
2. SYSTEM DESCRIPTION	4
3. MEASUREMENT UNCERTAINTY	4
4. PRODUCT INFORMATION	5
5. SUPPORT EQUIPMENT	6
6. TEST FACILITY	7
7. TEST ITEMS AND THE RESULTS	8
8. EN 55015 RADIATED EMISSION TEST	9
8.1. LIMITS OF RADIATED DISTURBANCES.....	9
8.2. BLOCK DIAGRAM OF TEST SETUP.....	9
8.3. PROCEDURE OF RADIATED EMISSION TEST.....	10
8.4. TEST RESULT OF RADIATED EMISSION TEST	11
9. EN 55015 RADIATED ELECTROMAGNETIC DISTURBANCE TEST	13
9.1. LIMITS OF RADIATED ELECTROMAGNETIC DISTURBANCE IN THE RANGE 9 KHZ TO 30 MHZ	13
9.2. BLOCK DIAGRAM OF TEST SETUP	14
9.3. TEST PROCEDURE.....	14
9.4. RESULT.....	15
10. EN 61000-4-2 ESD IMMUNITY TEST	18
10.1. BLOCK DIAGRAM OF TEST SETUP	18
10.2. TEST PROCEDURE	19
10.3. PERFORMANCE & RESULT	19
11. EN 61000-4-3 RS IMMUNITY TEST	20
11.1. BLOCK DIAGRAM OF TEST SETUP	20
11.2. TEST PROCEDURE	21
11.3. PERFORMANCE & RESULT	21

APPENDIX A: PHOTOGRAPHS OF TEST SETUP
 APPENDIX B: PHOTOGRAPHS OF EUT



TEST REPORT

Test Report # 19A-000716-5 Date of Report Issue: March 6, 2019
 Date of Sample Received: February 27, 2019 Pages: Page 3 of 27

1. VERIFICATION OF CONFORMITY

Report Number	19A-000716-5
Applicant	Mid Ocean Brands B.V.
Address	7/F, Kings Tower, 111 King Lam Street, Cheung Sha Wan, Kowloon, Hong Kong
Manufacturer	Mid Ocean Brands B.V.
Address	7/F, Kings Tower, 111 King Lam Street, Cheung Sha Wan, Kowloon, Hong Kong
Factory	Mid Ocean Brands B.V.
Address	7/F, Kings Tower, 111 King Lam Street, Cheung Sha Wan, Kowloon, Hong Kong
Product Designation	MINI TOOL SET WITH LED LIGHT
Brand Name	N/A
Test Model	IT3874
Date of test	Feb.27, 2019 to Mar.01, 2019
Deviation	None
Condition of Test Sample	Normal
Test Result	PASS

***Note**

The above device has been tested by Hangzhou Asiainspection Testing Technology Co.,Ltd To determine the maximum emission levels emanating from the device and the severe levels of the device can endure and its performance criterion. The test record, data evaluation & Equipment Under Test (EUT) configurations represented are contained in this test report and Hangzhou Asiainspection Testing Technology Co.,Ltd is assumed full responsibility for the accuracy and completeness of test. Also, this report shows that the EUT is technically compliant with the requirement of the above standards.

This report applies to above tested sample only. This report shall not be reproduced except in full, without written approval of Hangzhou Asiainspection Testing Technology Co.,Ltd, this document may be altered or revised by Hangzhou Asiainspection Testing Technology Co.,Ltd, personal only, and shall be noted in the revision of the document.

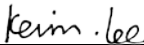
Approved by	
	Technical manager





TEST REPORT

Test Report # 19A-000716-5 Date of Report Issue: March 6, 2019
Date of Sample Received: February 27, 2019 Pages: Page 4 of 27

2. SYSTEM DESCRIPTION

TEST MODE DESCRIPTION		
NO.	TEST MODE DESCRIPTION	WORST
1	Lighting	V

Note: 1. V means EMI worst mode.

3. MEASUREMENT UNCERTAINTY

The uncertainty is calculated using the methods suggested in the "Guide to the Expression of Uncertainty in measurement" (GUM) published by ISO.

- Uncertainty of Radiated Emission, $U_c = \pm 3.9\text{dB}$



TEST REPORT

Test Report # 19A-000716-5 Date of Report Issue: March 6, 2019
Date of Sample Received: February 27, 2019 Pages: Page 5 of 27

4. PRODUCT INFORMATION

Housing Type	Plastic and metal
EUT Input Rating	DC 4.5V by Battery

I/O Port Information (Applicable Not Applicable)

I/O Port of EUT			
I/O Port Type	Number	Cable Description	Tested With
-	-	-	-



TEST REPORT

Test Report # 19A-000716-5 Date of Report Issue: March 6, 2019
Date of Sample Received: February 27, 2019 Pages: Page 6 of 27

5. SUPPORT EQUIPMENT

Device Type	Manufacturer	Model Name	Serial No.	Data Cable	Power Cable
-	-	-	-	-	-

Note:

1"- "means no any support device during testing



TEST REPORT

Test Report # 19A-000716-5 Date of Report Issue: March 6, 2019
Date of Sample Received: February 27, 2019 Pages: Page 7 of 27

6. TEST FACILITY

Site	Hangzhou Asiainspection Testing Technology Co.,Ltd.
Location	5th Floor, A2 Building, No. 1213, Huo Ju South Road, Binjiang District, Hangzhou, China

TEST EQUIPMENT OF RADIATED EMISSION TEST

Equipment	Manufacturer	Model	S/N	Cal. Date	Cal. Due
TEST RECEIVER	R&S	ESCI	10096	Jun.12, 2018	Jun.11, 2019
ANTENNA	SCHWARZBECK	VULB9168	D69250	Sep.28, 2017	Sep.27, 2019

TEST EQUIPMENT OF ESD TEST

Equipment	Manufacturer	Model	S/N	Cal. Date	Cal. Due
ESD	GeneratorEM	DITO	P1527160053	Mar.07, 2018	Mar.08, 2019

TEST EQUIPMENT OF RS IMMUNITY TEST

Description	Manufacturer	Model	S/N	Cal. Date	Cal. Due
SIGNAL GENERATOR	R&S	E4421B	MY43351603	May.15, 2018	May.14, 2019
ANTENNA	SCHWARZBECK	VULB9168	D69250	Aug.28, 2018	Aug.27, 2019
POWER SENSOR	R&S	URV5-Z4	100124	May.15, 2018	May.14, 2019
POWER METER	R&S	NRVD	8323781027	May.15, 2018	May.14, 2019
POWER AMPLIFIER	KALMUS	7100LC	04-02/17-06-001	Jun.12, 2018	Jun.11, 2019
RF AMPLIFIER	Milmega	AS01004-55_55	1004793	Jun.12, 2018	Jun.11, 2019
HORN ANTENNA	ETS LINDGREN	3117	00034609	May.26, 2018	May.25, 2019



TEST REPORT

Test Report # 19A-000716-5 Date of Report Issue: March 6, 2019
Date of Sample Received: February 27, 2019 Pages: Page 8 of 27

7. TEST ITEMS AND THE RESULTS

Test item	Test Requirement	Test Method	Class/Severity	Result
CONDUCTED EMISSION	EN 55015	EN 55015	0.009MHz -30MHz	N/A
RADIATED EMISSION	EN 55015	EN 55015	30MHz -300MHz	PASS
RADIATED ELECTROMAGNETIC DISTURBANCE	EN 55015	EN 55015	0.009MHz -30MHz	PASS
Harmonic current emission	EN 61000-3-2	EN 61000-3-2	Class C	N/A
Voltage fluctuations & flicker	EN 61000-3-3	EN 61000-3-3	§5 of EN 61000-3-3	N/A
Electrostatic Discharge Immunity	EN 61547	EN 61000-4-2	± 8.0 kV (Air Discharge) ± 4.0 kV (Contact Discharge) ± 4.0 kV (Indirect Discharge)	PASS
Radiated RF Electromagnetic	EN 61547	EN 61000-4-3	3V/m with 80% AM. 1kHz Modulation.	PASS
Electrical fast transient/burst Immunity	EN 61547	EN 61000-4-4	+/- 1kV for Power Supply Lines	N/A
SURGE IMMUNITY	EN 61547	EN 61000-4-5	>25W +/-1kV (Line to Line) +/-2kV (Line to Ground) <25W +/-0.5kV (Line to Line) +/-1kV (Line to Ground)	N/A
Immunity to Conducted Disturbances Induced by RF fields	EN 61547	EN 61000-4-6	3V with 80% AM. 1 kHz Modulation	N/A
Power Frequency Magnetic Fields	EN 61547	EN61000-4-8	50/60Hz 3A/m	N/A
Voltage dips and short interruptions immunity	EN 61547	EN 61000-4-11	PHASE ANGLE 0, 45, 90, 135, 180, 225, 270, 315 degrees	N/A

Note: N/A means not applicable.



TEST REPORT

Test Report # 19A-000716-5 Date of Report Issue: March 6, 2019
Date of Sample Received: February 27, 2019 Pages: Page 9 of 27

8. EN 55015 RADIATED EMISSION TEST

8.1. LIMITS OF RADIATED DISTURBANCES

AT 10M DISTANCES

Frequency (MHz)	Distance (m)	Maximum Field Strength Limit (dBuV/m Q.P.)
30-230	10	30.00
230-300	10	37.00

AT 3M DISTANCES

Frequency (MHz)	Distance (m)	Maximum Field Strength Limit (dBuV/m Q.P.)
30-230	3	40.00
230-300	3	47.00

Note: The lower limit shall apply at the transition frequency

8.2. BLOCK DIAGRAM OF TEST SETUP

System Diagram of Connections between EUT and Simulators

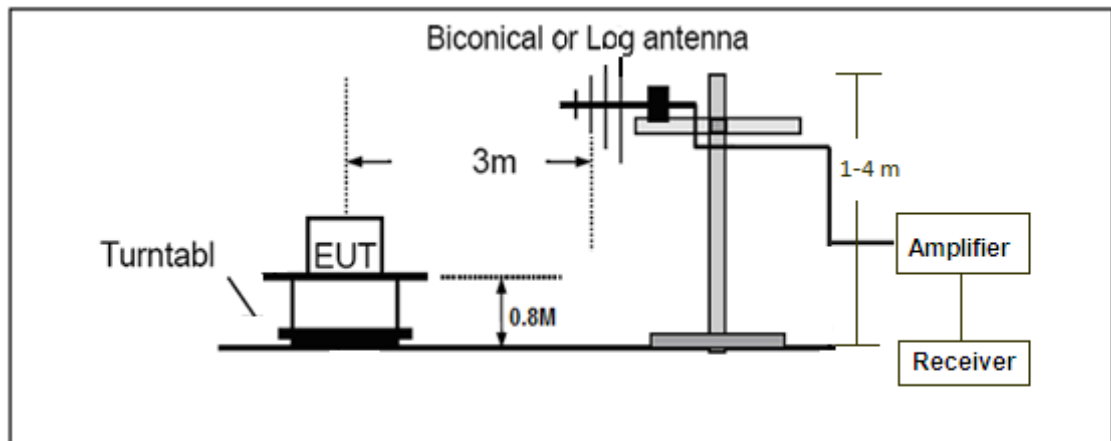



TEST REPORT

Test Report # 19A-000716-5 Date of Report Issue: March 6, 2019
Date of Sample Received: February 27, 2019 Pages: Page 10 of 27

8.3. PROCEDURE OF RADIATED EMISSION TEST

- (1) The equipment was set up as per the test configuration to simulate typical actual usage per the user's manual. When the EUT is a tabletop system, a wooden turntable with a height of 0.8 meters is used which is placed on the ground plane as per EN 55015 (see Test Facility for the dimensions of the ground plane used). When the EUT is a floor-standing equipment, it is placed on the ground plane which has a 3-12 mm non-conductive covering to insulate the EUT from the ground plane.
- (2) Support equipment, if needed, was placed as per EN 55015.
- (3) All I/O cables were positioned to simulate typical actual usage as per EN 55015.
- (4) The EUT was turned on.
- (5) The antenna was placed at 3 meters away from the EUT as stated in EN 55015. The antenna connected to the Analyzer via a cable and at times a pre-amplifier would be used.
- (6) The Analyzer / Receiver quickly scanned from 30MHz to 1000MHz. The EUT test program was started. Emissions were scanned and measured rotating the EUT to 360 degrees and positioning the antenna 1 to 4 meters above the ground plane, in both the vertical and the horizontal polarization, to maximize the emission reading level.
- (7) The test mode(s) were scanned during the test:
- (8) Recorded at least the six highest emissions. Emission frequency, amplitude, antenna position, polarization and turntable position were recorded into a computer in which correction factors were used to calculate the emission level and compare reading to the applicable limit and Q.P./Peak reading is presented.



TEST REPORT

Test Report # 19A-000716-5 Date of Report Issue: March 6, 2019
 Date of Sample Received: February 27, 2019 Pages: Page 11 of 27

8.4. TEST RESULT OF RADIATED EMISSION TEST

Radiated Emission Test at 3m Distance-Horizontal

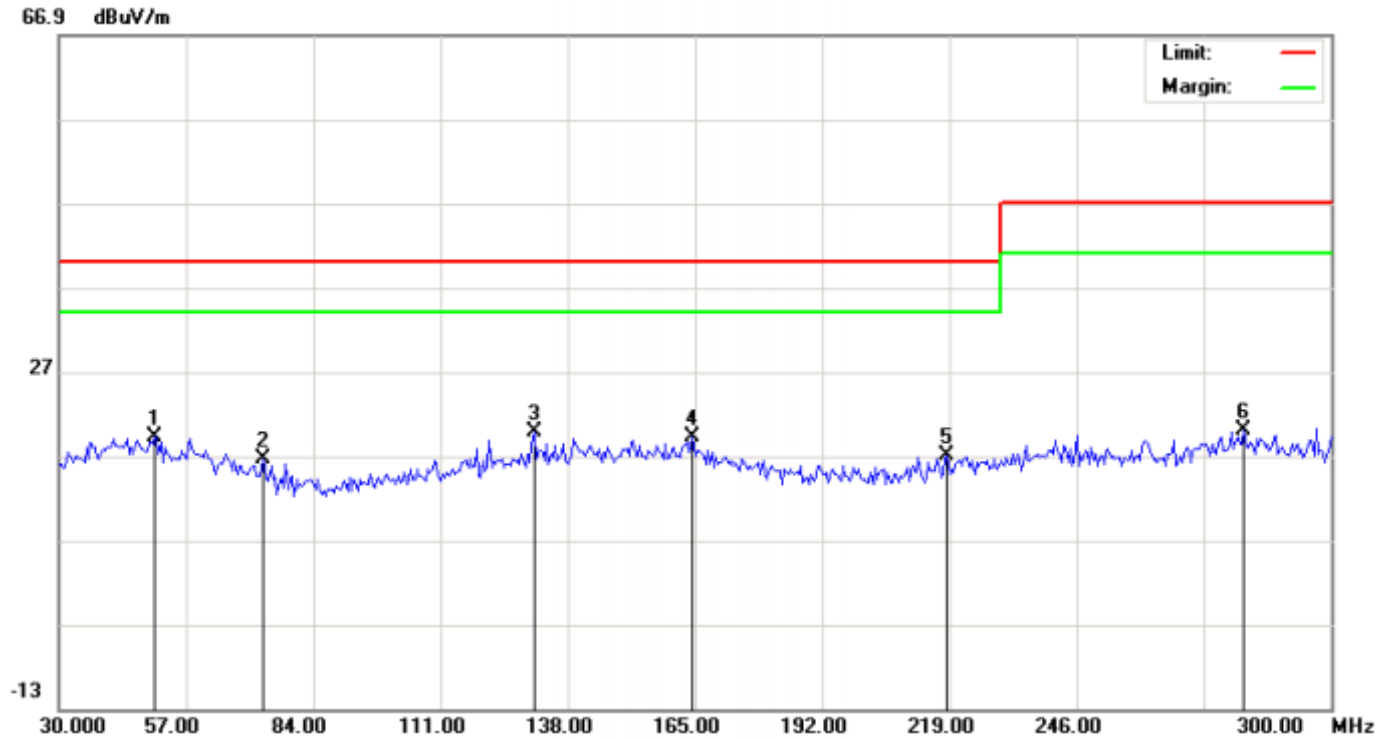

No.	Mk	Freq.	Reading	Factor	Measurement	Limit	Over	Detector
		MHz	dBuV	dB/m	dBuV/m	dBuV/m	dB	
1		50.2500	-0.43	19.71	19.28	40.00	-20.72	peak
2		73.2000	0.20	16.42	16.62	40.00	-23.38	peak
3	*	130.8000	1.22	18.65	19.87	40.00	-20.13	peak
4		164.5500	0.39	18.72	19.11	40.00	-20.89	peak
5		218.5500	-0.21	17.15	16.94	40.00	-23.06	peak
6		281.5500	0.13	19.90	20.03	47.00	-26.97	peak

RESULT: PASS



TEST REPORT

Test Report # 19A-000716-5 Date of Report Issue: March 6, 2019
 Date of Sample Received: February 27, 2019 Pages: Page 12 of 27

Radiated Emission Test at 3m Distance-Vertical

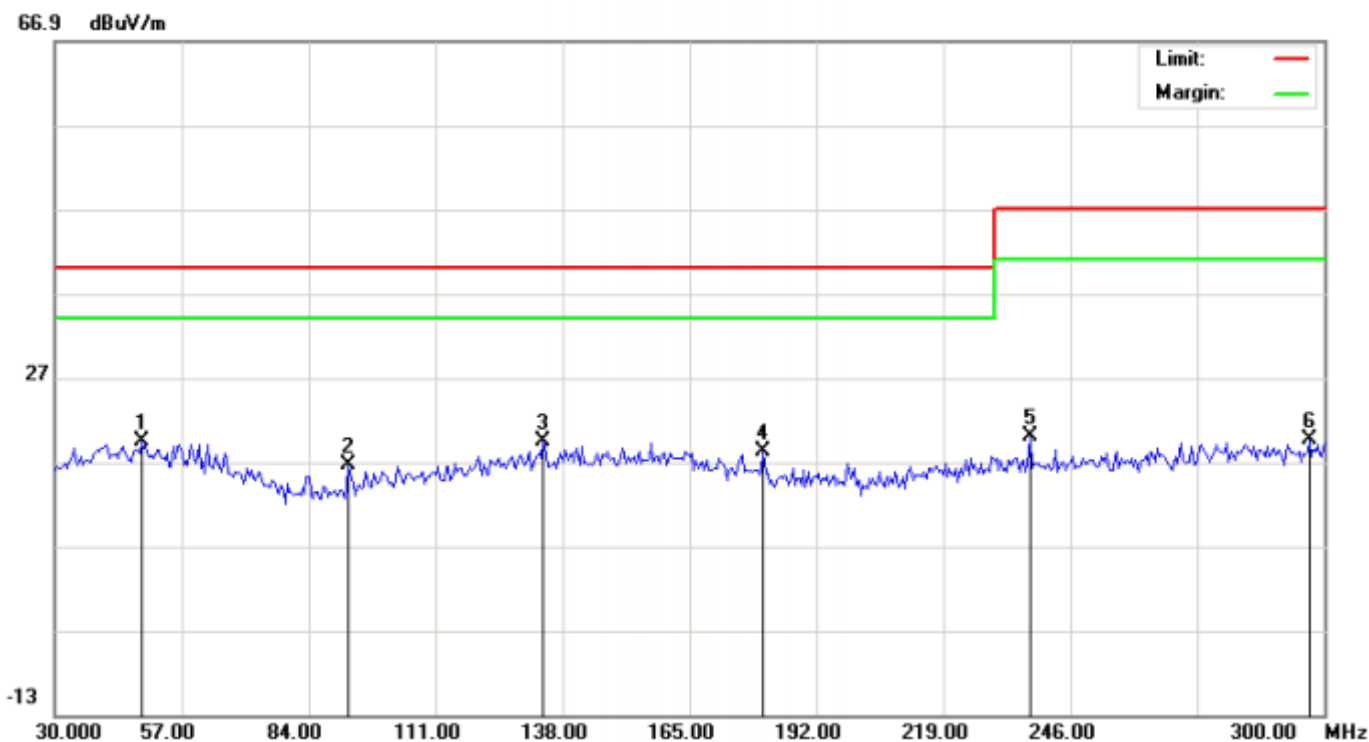

No.	Mk	Freq.	Reading	Factor	Measurement	Limit	Over	Detector
		MHz	dBuV	dB/m	dBuV/m	dBuV/m	dB	
1		48.4500	-0.42	19.79	19.37	40.00	-20.63	peak
2		92.5500	1.41	15.24	16.65	40.00	-23.35	peak
3	*	133.9500	0.62	18.85	19.47	40.00	-20.53	peak
4		180.7500	1.15	17.09	18.24	40.00	-21.76	peak
5		237.4500	1.59	18.48	20.07	47.00	-26.93	peak
6		296.8500	0.09	19.54	19.63	47.00	-27.37	peak

RESULT: PASS

Note:

Level(dBuV/m)=Reading(dBuV)+Factor(dB/m)

Factor(dB/m)=Antenna Factor(dB/m)+Cable loss(dB)+Attenuation(dB)for Attenuator

Margin= Limit-Level



TEST REPORT

Test Report # 19A-000716-5 Date of Report Issue: March 6, 2019
Date of Sample Received: February 27, 2019 Pages: Page 13 of 27

9. EN 55015 RADIATED ELECTROMAGNETIC DISTURBANCE TEST

9.1. LIMITS OF RADIATED ELECTROMAGNETIC DISTURBANCE IN THE RANGE 9 KHZ TO 30 MHZ

Frequency Range	Limits for Loop Diameter dB(uA)*		
	2m	3m	4m
9 KHz-70 KHz	88*	81*	75*
70 KHz-150 KHz	88 to 58**	81 to 51**	75 to 45**
150 kHz-3.0 MHz	58 to 22**	51 to 15**	45 to 9**
3.0 MHz-30 MHz	22***	15 to 16***	9 to 12***

Note:

*At the transition frequency, the lower limit applies.

** Decreasing linearly with the logarithm of the frequency. For electrode less lamps and luminaries, the limit in the frequency range of 2.2 MHz to 3.0 MHz is 58 dB(uA) for 2m, 51 dB(uA) for 3m and 45 dB(uA) for 4m loop diameter.

***Increasing linearly with the logarithm of the frequency.

TEST REPORT

Test Report # 19A-000716-5 Date of Report Issue: March 6, 2019
 Date of Sample Received: February 27, 2019 Pages: Page 14 of 27

9.2. BLOCK DIAGRAM OF TEST SETUP

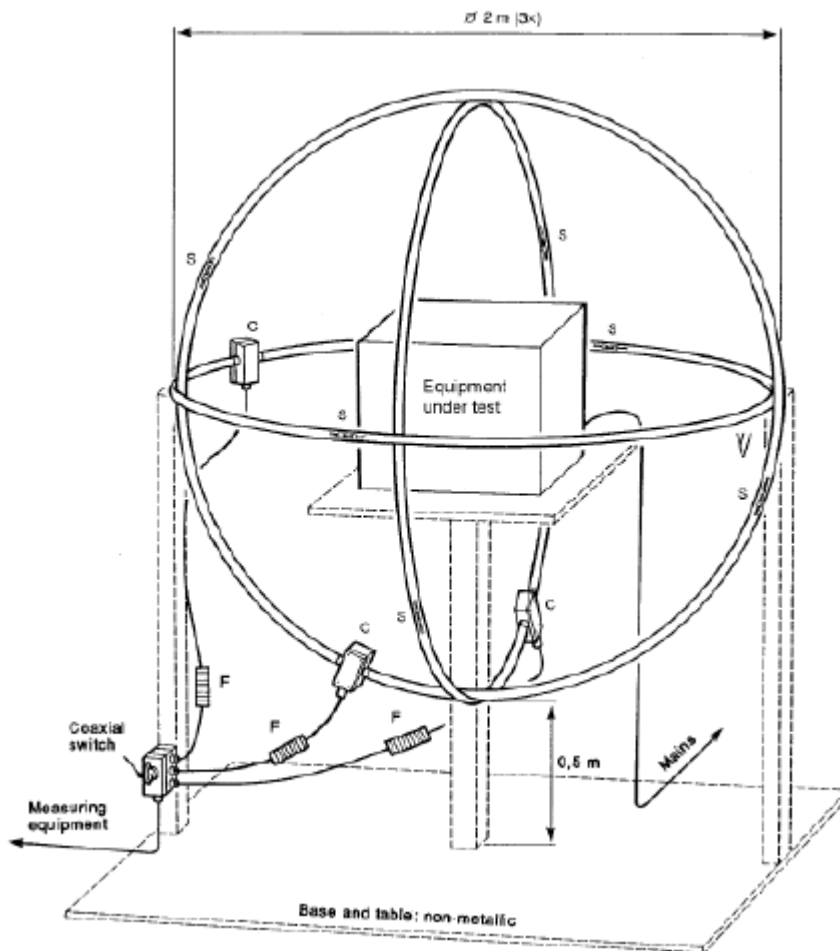

9.3. TEST PROCEDURE

The magnetic component shall be measured by means of a loop antenna as described in EN 55015. The lighting equipment shall be placed in the centre of the antenna, and the position is not critical. The test object was operated at its upper limit of its rated voltage and its rated frequency. The induced current in the loop antenna is measured by means of a current probe(1V/A) and the CISPR measuring receiver. By means of a coaxial switch the three field directions can be measured in sequence. Each value shall fulfill the requirements given.



TEST REPORT

Test Report # 19A-000716-5 Date of Report Issue: March 6, 2019
 Date of Sample Received: February 27, 2019 Pages: Page 15 of 27

9.4. RESULT

X

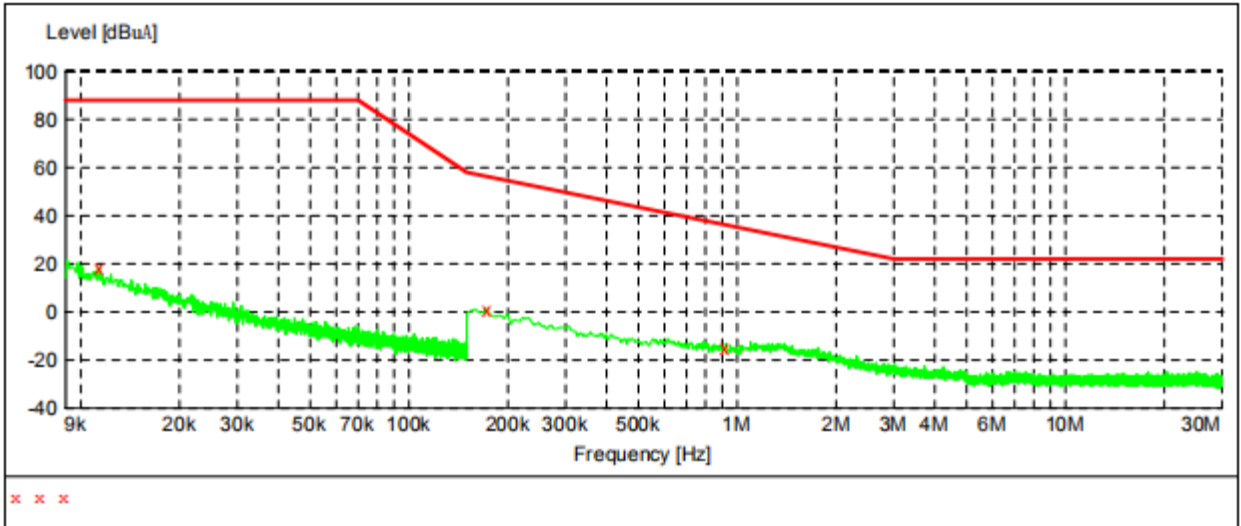

MEASUREMENT RESULT:

Frequency MHz	Level dBuA	Transd dB	Limit dBuA	Margin dB	Det.	Loop
0.011400	18.10	2.2	88	69.9	PK	X
0.172500	0.70	-21.0	56	55.6	PK	X
0.924000	-14.80	-31.6	36	51.0	PK	X

RESULT: PASS



TEST REPORT

Test Report # 19A-000716-5 Date of Report Issue: March 6, 2019
 Date of Sample Received: February 27, 2019 Pages: Page 16 of 27

Y

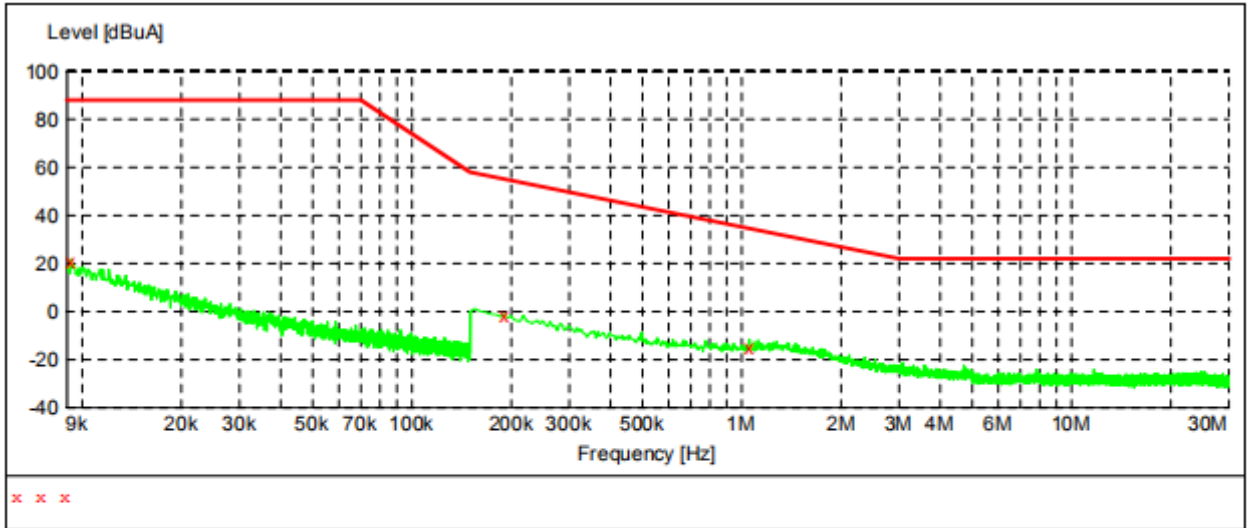

MEASUREMENT RESULT :

Frequency MHz	Level dBuA	Transd dB	Limit dBuA	Margin dB	Det.	Loop
0.009240	20.30	3.0	88	67.7	PK	Y
0.190500	-1.80	-22.1	55	56.9	PK	Y
1.054500	-15.30	-32.0	35	49.9	PK	Y

RESULT: PASS



TEST REPORT

Test Report # 19A-000716-5 Date of Report Issue: March 6, 2019
 Date of Sample Received: February 27, 2019 Pages: Page 17 of 27

Z

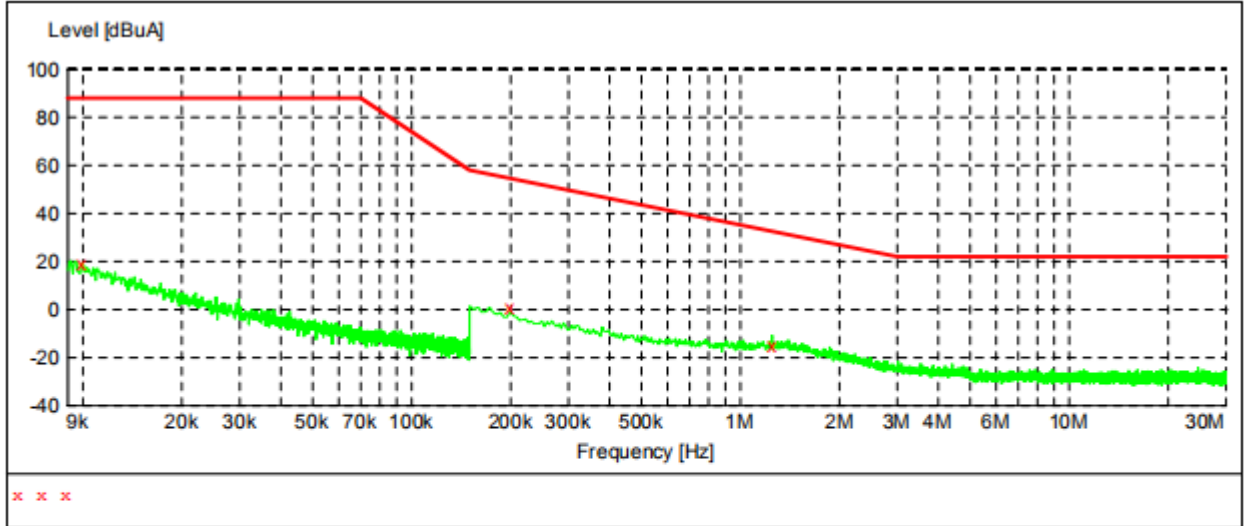

MEASUREMENT RESULT :

Frequency MHz	Level dBuA	Transd dB	Limit dBuA	Margin dB	Det.	Loop
0.009960	18.90	3.0	88	69.1	PK	Z
0.199500	0.40	-22.7	55	54.2	PK	Z
1.248000	-14.90	-32.1	33	47.4	PK	Z

RESULT: PASS



TEST REPORT

Test Report # 19A-000716-5 Date of Report Issue: March 6, 2019
Date of Sample Received: February 27, 2019 Pages: Page 18 of 27

10. EN 61000-4-2 ESD IMMUNITY TEST

ELECTROSTATIC DISCHARGE (ESD) IMMUNITY TEST

Port	Enclosure
Basic Standard	EN 61000-4-2
Test Level	± 8.0 kV (Air Discharge) ± 4.0 kV (Contact Discharge) ± 4.0 kV (Indirect Discharge)
Standard require	B
Temperature	24 °C
Humidity	53%

10.1. BLOCK DIAGRAM OF TEST SETUP

(The 470 k ohm resistors are installed per standard requirement)

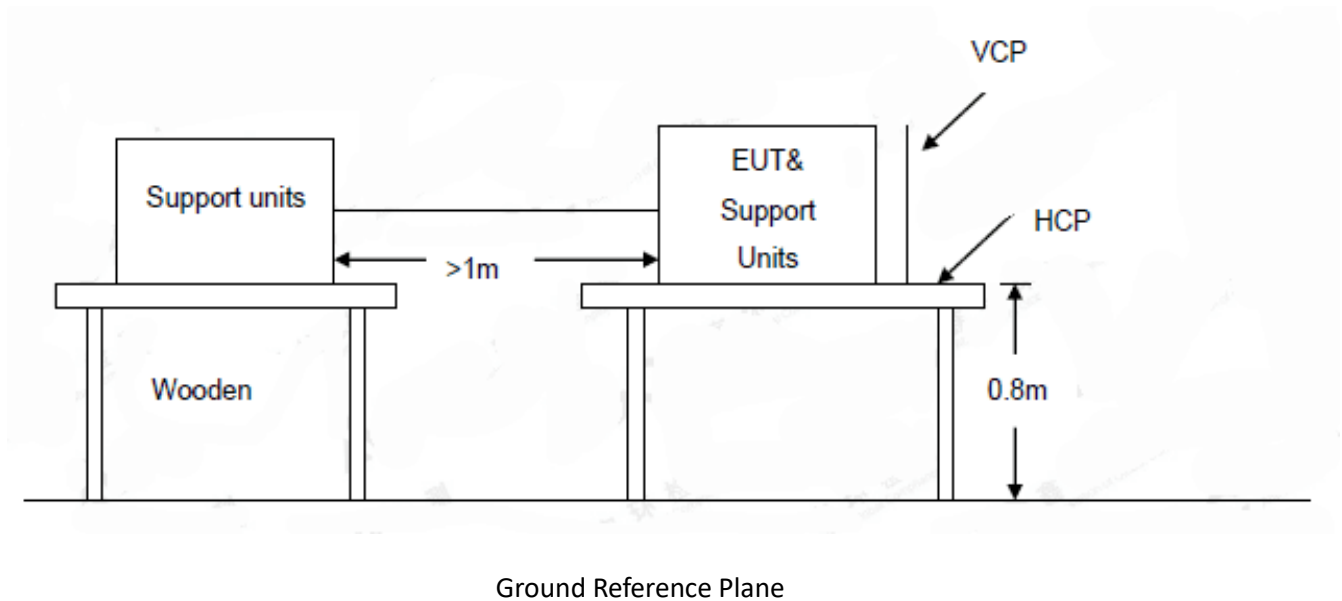



TEST REPORT

Test Report # 19A-000716-5 Date of Report Issue: March 6, 2019
 Date of Sample Received: February 27, 2019 Pages: Page 19 of 27

10.2. TEST PROCEDURE

The EUT was located 0.1 m minimum from all side of the HCP.
 The support units were located 1 m minimum away from the EUT.
 EUT worked with resistance load, and make sure EUT worked normally.
 Activates the communication function if the EUT with such port(s).
 As per the requirement of EN 61547: Contact discharge is the preferred test method, twenty discharges (10 with positive and 10 with negative polarity) shall be applied on each accessible metallic part of the enclosure, terminals are excluded. Air discharges shall be used where contact discharges cannot be applied. Discharges shall be applied on the horizontal or vertical coupling planes as specified in EN 61000-4-2.
 The following test condition was followed during the tests.
 Note: As per the A2 to EN 61000-4-2, a bleed resistor cable is connected between the EUT and HCP during the test.

The electrostatic discharges were applied as follows:

Voltage	Coupling	Test Performance	Result
± 4kV	Contact Discharge	No function loss	A
± 4kV	Indirect Discharge HCP (Front)	No function loss	A
± 4kV	Indirect Discharge HCP (Left)	No function loss	A
± 4kV	Indirect Discharge HCP (Back)	No function loss	A
± 4kV	Indirect Discharge HCP (Right)	No function loss	A
± 4kV	Indirect Discharge VCP (Front)	No function loss	A
± 4kV	Indirect Discharge VCP (Left)	No function loss	A
± 4kV	Indirect Discharge VCP (Back)	No function loss	A
± 4kV	Indirect Discharge VCP (Right)	No function loss	A
± 8kV	Air Discharge	No function loss	A

10.3. PERFORMANCE & RESULT

Criteria A:	The apparatus continues to operate as intended. No degradation of performance or loss of function is allowed below a performance level specified by the manufacturer, when the apparatus is used as intended. In some cases the performance level may be replaced by a permissible loss of performance.
Criteria B:	The apparatus continues to operate as intended after the test. No degradation of performance or loss of function is allowed below a performance level specified by the manufacturer, when the apparatus is used as intended. In some cases the performance level may be replaced by a permissible loss of performance. During the test, degradation of performance is however allowed.
Criteria C:	Temporary loss of function is allowed, provided the functions self recoverable or can be restored by the operation of controls.

PASS FAIL



TEST REPORT

Test Report #

19A-000716-5

Date of Report Issue:

March 6, 2019

Date of Sample Received:

February 27, 2019

Pages:

Page 20 of 27

11. EN 61000-4-3 RS IMMUNITY TEST

RADIATED ELECTROMAGNETIC FIELD IMMUNITY TEST

Port	Enclosure
Basic Standard	EN 61000-4-3
Test Level	3V/m with 80% AM. 1kHz Modulation.
Standard require	A
Temperature	23°C
Humidity	54%

11.1. BLOCK DIAGRAM OF TEST SETUP

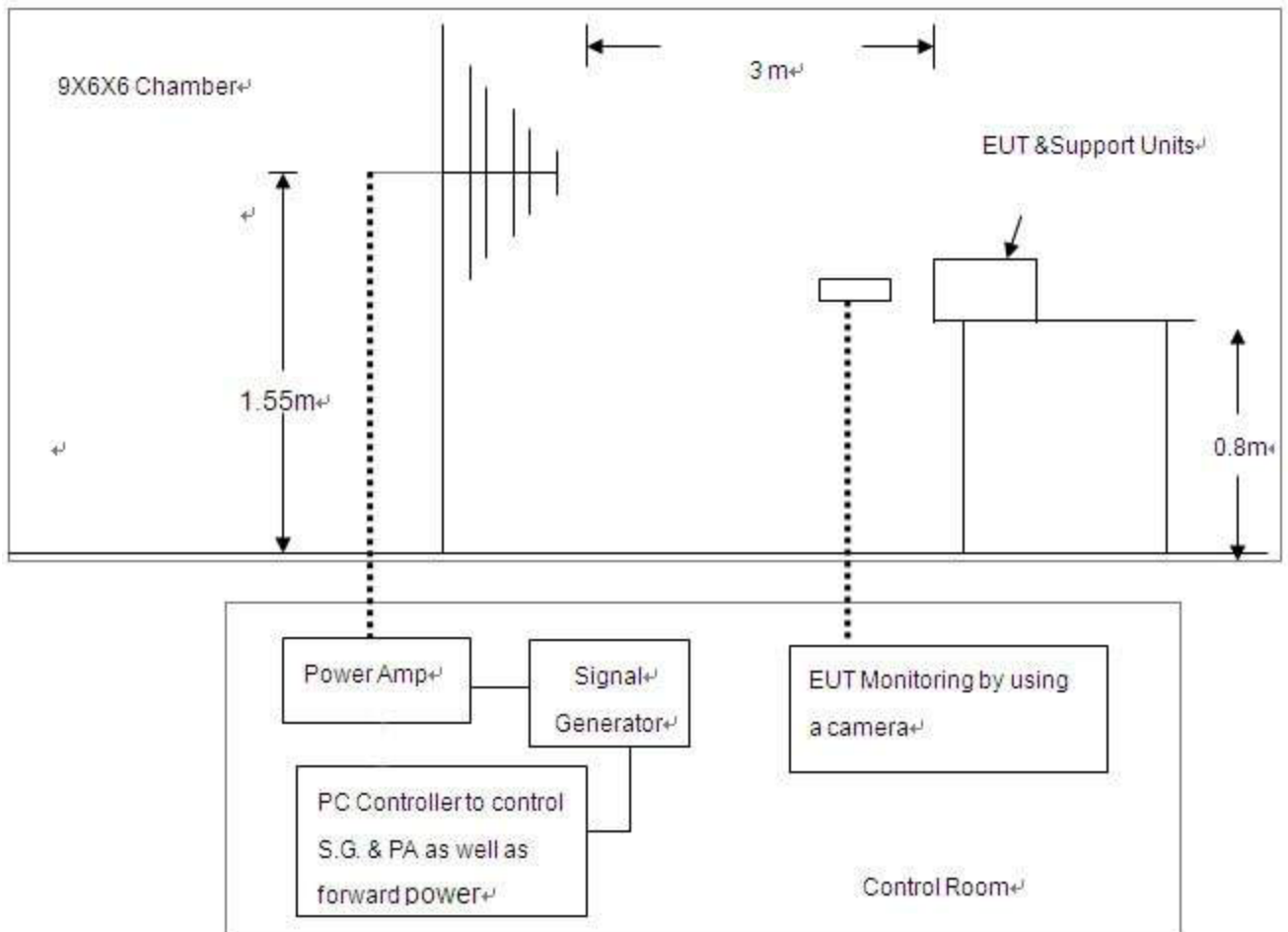



TEST REPORT

Test Report # 19A-000716-5 Date of Report Issue: March 6, 2019
 Date of Sample Received: February 27, 2019 Pages: Page 21 of 27

11.2. TEST PROCEDURE

The EUT was located at the edge of supporting table keep 3 meter away from transmitting antenna, it just the calibrated square area of field uniformity. The support units were located outside of the uniformity area, but the cable(s) connected with EUT were exposed to the calibrated field as per EN 61000-4-3.

EUT worked with resistance load, and make sure EUT worked normally.

Setting the testing parameters of RS test software per EN 61000-4-3.

Performing the test at each side of with specified level (3V/m) at 1% steps and test frequency from 80MHz to 1000MHz

Recording the test result in following table.

EN 61000-4-3 Final test conditions:

Test level: 3V/m

Steps: 1 % of fundamental

Dwell Time: 1 sec

Range (MHz)	Field	Modulation	Polarity	Position	Test Performance	Result
80-1000	3V/m	AM	H	Front	No function loss	A
80-1000	3V/m	AM	H	Left	No function loss	A
80-1000	3V/m	AM	H	Back	No function loss	A
80-1000	3V/m	AM	H	Right	No function loss	A
80-1000	3V/m	AM	V	Front	No function loss	A
80-1000	3V/m	AM	V	Left	No function loss	A
80-1000	3V/m	AM	V	Back	No function loss	A
80-1000	3V/m	AM	V	Right	No function loss	A

11.3. PERFORMANCE & RESULT

Criteria A:	The apparatus continues to operate as intended. No degradation of performance or loss of function is allowed below a performance level specified by the manufacturer, when the apparatus is used as intended. In some cases the performance level may be replaced by a permissible loss of performance.
Criteria B:	The apparatus continues to operate as intended after the test. No degradation of performance or loss of function is allowed below a performance level specified by the manufacturer, when the apparatus is used as intended. In some cases the performance level may be replaced by a permissible loss of performance. During the test, degradation of performance is however allowed.
Criteria C:	Temporary loss of function is allowed, provided the functions self recoverable or can be restored by the operation of controls.

PASS FAIL

TEST REPORT

Test Report # 19A-000716-5 Date of Report Issue: March 6, 2019
Date of Sample Received: February 27, 2019 Pages: Page 22 of 27

APPENDIX A: PHOTOGRAPHS OF TEST SETUP

EN 55015 RADIATED EMISSION TEST SETUP



EN 61000-4-2 ESD IMMUNITY TEST SETUP





TEST REPORT

Test Report # 19A-000716-5 Date of Report Issue: March 6, 2019
Date of Sample Received: February 27, 2019 Pages: Page 23 of 27

EN 55015 RADIATED ELECTROMAGNETIC DISTURBANCE TEST



EN 61000-4-3 RS IMMUNITY TEST SETUP

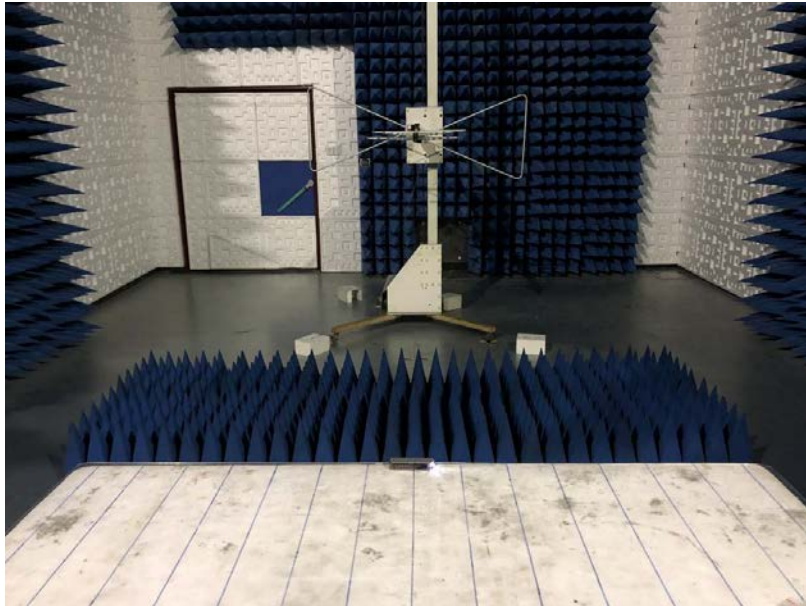



TEST REPORT

Test Report # 19A-000716-5 Date of Report Issue: March 6, 2019
Date of Sample Received: February 27, 2019 Pages: Page 24 of 27

APPENDIX B: PHOTOGRAPHS OF EUT

TOP VIEW OF EUT

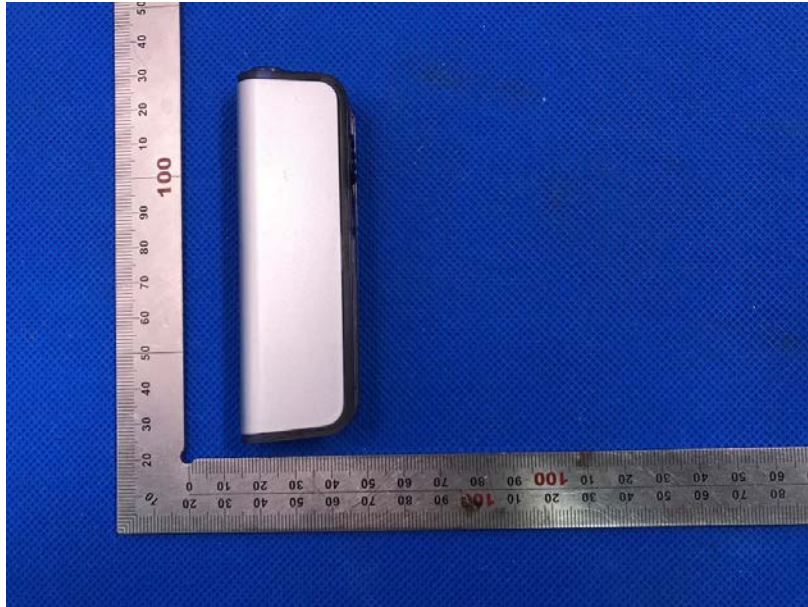

BOTTOM VIEW OF EUT

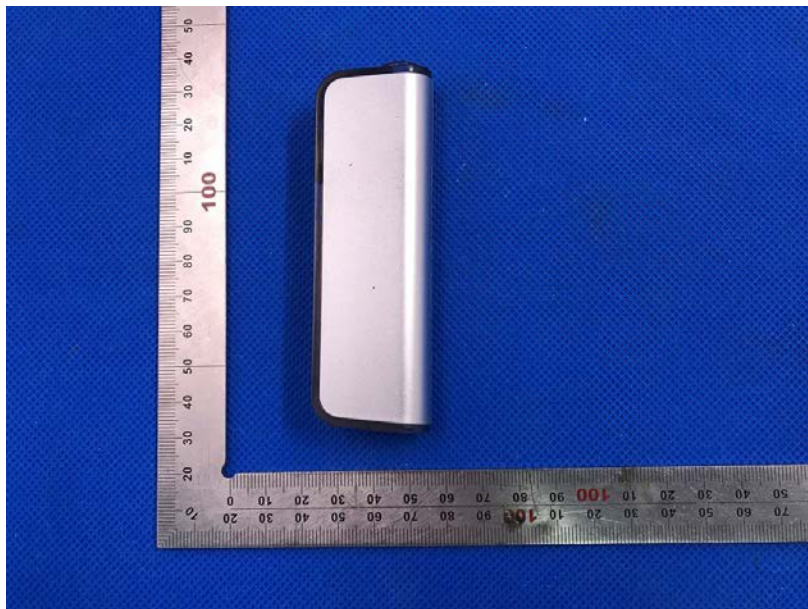

TEST REPORT

Test Report # 19A-000716-5 Date of Report Issue: March 6, 2019
Date of Sample Received: February 27, 2019 Pages: Page 25 of 27

FRONT VIEW OF EUT



BACK VIEW OF EUT





TEST REPORT

Test Report # 19A-000716-5
Date of Sample Received: February 27, 2019

Date of Report Issue: March 6, 2019
Pages: Page 26 of 27

LEFT VIEW OF EUT



RIGHT VIEW OF EUT

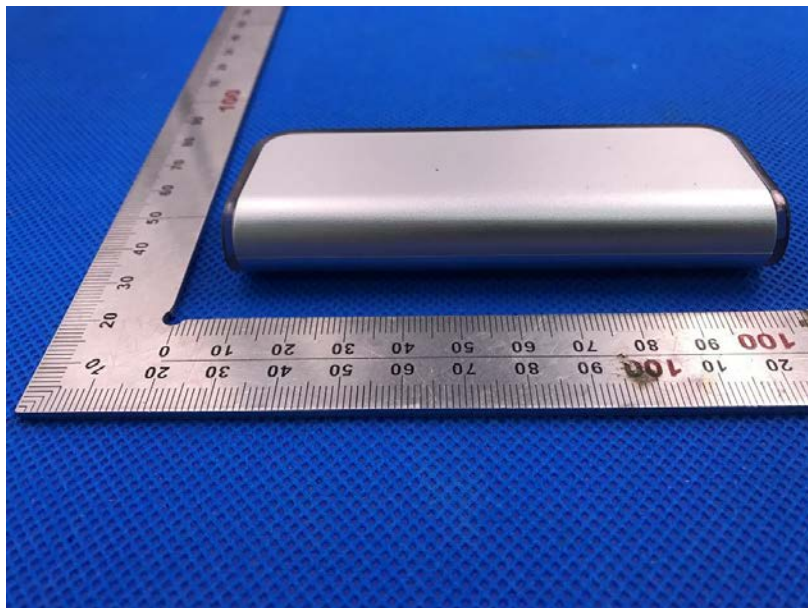



TEST REPORT

Test Report #

19A-000716-5

Date of Report Issue:

March 6, 2019

Date of Sample Received:

February 27, 2019

Pages:

Page 27 of 27

OPEN VIEW OF EUT



-End Report-