EMC Test Report

Report No.: AGC03507190308EE01

PRODUCT DESIGNATION : 3 in 1 Emergency hammer
BRAND NAME : N/A
MODEL NAME : M08470
CLIENT : MID OCEAN BRANDS B.V
DATE OF ISSUE : Mar.21, 2019
STANDARD(S) : EN 55015:2013+A1:2015
: EN 61547:2009
REPORT VERSION : V1.0

Attestation of *Global Compliance (Shenzhen) Co., Ltd*

CAUTION:

This report shall not be reproduced except in full without the written permission of the test laboratory and shall not be quoted out of context.



REPORT REVISE RECORD

| Report Version | Revise Time | Issued Date | Valid Version | Notes |
|-----------------------|--------------------|--------------------|----------------------|-----------------|
| V1.0 | / | Mar.21, 2019 | Valid | Initial release |

TABLE OF CONTENTS

| | |
|--|-----------|
| 1. VERIFICATION OF CONFORMITY | 4 |
| 2. SYSTEM DESCRIPTION | 5 |
| 3. MEASUREMENT UNCERTAINTY | 5 |
| 4. PRODUCT INFORMATION | 6 |
| 5. SUPPORT EQUIPMENT | 7 |
| 6. TEST FACILITY | 8 |
| 7. TEST ITEMS AND THE RESULTS | 9 |
| 8. EN 55015 RADIATED EMISSION TEST | 10 |
| 8.1. LIMITS OF RADIATED DISTURBANCES | 10 |
| 8.2. BLOCK DIAGRAM OF TEST SETUP | 10 |
| 8.3. PROCEDURE OF RADIATED EMISSION TEST | 11 |
| 8.4. TEST RESULT OF RADIATED EMISSION TEST | 12 |
| 9. EN 55015 RADIATED ELECTROMAGNETIC DISTURBANCE TEST | 14 |
| 9.1. LIMITS OF RADIATED ELECTROMAGNETIC DISTURBANCE IN THE RANGE 9 KHZ TO 30 MHZ | 14 |
| 9.2. BLOCK DIAGRAM OF TEST SETUP | 15 |
| 9.3. TEST PROCEDURE | 15 |
| 9.4. RESULT | 15 |
| 10. EN 61000-4-2 ESD IMMUNITY TEST | 16 |
| 10.1. BLOCK DIAGRAM OF TEST SETUP | 16 |
| 10.2. TEST PROCEDURE | 17 |
| 10.3. PERFORMANCE & RESULT | 17 |
| 11. EN 61000-4-3 RS IMMUNITY TEST | 18 |
| 11.1. BLOCK DIAGRAM OF TEST SETUP | 18 |
| 11.2. TEST PROCEDURE | 19 |
| 11.3. PERFORMANCE & RESULT | 19 |
| 12. EN 61000-4-8 PFMF TEST | 20 |
| 12.1. BLOCK DIAGRAM OF TEST SETUP | 20 |
| 12.2. TEST PROCEDURE | 21 |
| 12.3. PERFORMANCE & RESULT | 21 |
| APPENDIX A: PHOTOGRAPHS OF TEST SETUP | 22 |
| APPENDIX B: PHOTOGRAPHS OF EUT | 24 |

1. VERIFICATION OF CONFORMITY

| | |
|---------------------------------|--|
| Applicant | MID OCEAN BRANDS B.V |
| Address | 7/F, Kings Tower, 111 King Lam Street, Cheung Sha Wan, Kowloon, Hong Kong. |
| Manufacturer | MID OCEAN BRANDS B.V |
| Address | 7/F, Kings Tower, 111 King Lam Street, Cheung Sha Wan, Kowloon, Hong Kong. |
| Factory | MID OCEAN BRANDS B.V |
| Address | 7/F, Kings Tower, 111 King Lam Street, Cheung Sha Wan, Kowloon, Hong Kong. |
| Product Designation | 3 in 1 Emergency hammer |
| Brand Name | N/A |
| Test Model | MO8470 |
| Date of test | Mar.18, 2019 to Mar.20, 2019 |
| Deviation | None |
| Condition of Test Sample | Normal |
| Test Result | Pass |
| Report Template | AGCRT-EC-LT/DC(2013-03-01) |

The above equipment was tested by Attestation of Global Compliance (Shenzhen) Co., Ltd. for compliance with the requirements set forth in the Technical Standards mentioned above. This said equipment in the configuration described in this report shows the maximum emission levels emanating from equipment and the level of the immunity endurance of the equipment are within the compliance requirements.

The test results of this report relate only to the tested sample identified in this report.

Tested By

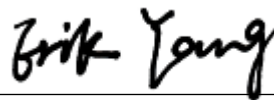

Erik Yang(Yang Jianmin)

Mar.21, 2019

Reviewed By



Stone Zhou(Zhou Dong)

Mar.21, 2019

Approved By



Forrest Lei(Lei Yonggang)
Authorized Officer

Mar.21, 2019

2. SYSTEM DESCRIPTION

| TEST MODE DESCRIPTION | | |
|-----------------------|-----------------------|-------|
| NO. | TEST MODE DESCRIPTION | WORST |
| 1 | Light on mode | V |

Note: 1.V means EMI worst mode.

3. MEASUREMENT UNCERTAINTY

The uncertainty is calculated using the methods suggested in the "Guide to the Expression of Uncertainty in measurement" (GUM) published by ISO.

- Uncertainty of Radiated Emission, $U_c = \pm 3.9\text{dB}$

4. PRODUCT INFORMATION

| | |
|-------------------------|--------------------|
| Housing Type | Plastic and metal |
| EUT Input Rating | DC 4.5V by battery |

I/O Port Information (Applicable Not Applicable)

| I/O Port of EUT | | | |
|-----------------|--------|-------------------|-------------|
| I/O Port Type | Number | Cable Description | Tested With |
| -- | -- | -- | -- |

5. SUPPORT EQUIPMENT

| Device Type | Manufacturer | Model Name | Serial No. | Data Cable | Power Cable |
|-------------|--------------|------------|------------|------------|-------------|
| -- | -- | -- | -- | -- | -- |

Note:

1. "--" means no any support device during testing.

6. TEST FACILITY

| | |
|-----------------|---|
| Site | Attestation of Global Compliance (Shenzhen) Co., Ltd |
| Location | 1-2/F, Building 19, Junfeng Industrial Park, Chongqing Road, Heping Community, Fuhai Street, Bao 'an District, Shenzhen, Guangdong, China |

TEST EQUIPMENT OF RADIATED EMISSION TEST

| Equipment | Manufacturer | Model | S/N | Cal. Date | Cal. Due |
|---------------|--------------|----------|--------|--------------|--------------|
| TEST RECEIVER | R&S | ESCI | 10096 | Jun.12, 2018 | Jun.11, 2019 |
| ANTENNA | SCHWARZBECK | VULB9168 | D69250 | Sep.28, 2017 | Sep.27, 2019 |

TEST EQUIPMENT OF ESD TEST

| Equipment | Manufacturer | Model | S/N | Cal. Date | Cal. Due |
|---------------|--------------|---------|-----|--------------|--------------|
| ESD Simulator | Schaffner | NSG 438 | 782 | Oct.25, 2018 | Oct.24, 2019 |

TEST EQUIPMENT OF RS IMMUNITY TEST

| Description | Manufacturer | Model | S/N | Cal. Date | Cal. Due |
|----------------------------------|--------------|-------------------|---------------------|--------------|--------------|
| SIGNAL GENERATOR | R&S | E4421B | MY4335160 3 | May.15, 2018 | May.14, 2019 |
| ANTENNA | SCHWARZBCK | VULB9168 | D69250 | Sep.28, 2017 | Sep.27, 2019 |
| POWER SENSOR | R&S | URV5-Z4 | 100124 | May.15, 2018 | May.14, 2019 |
| POWER METER | R&S | NRVD | 8323781027 | May.15, 2018 | May.14, 2019 |
| POWER AMPLIFIER | KALMUS | 7100LC | 04-02/17- 06-001 | Jun.12, 2018 | Jun.11, 2019 |
| RF AMPLIFIER | Milmega | AS0104- 55_55 | 1004793 | Jun.12, 2018 | Jun.11, 2019 |
| HORN ANTENNA | ETS LINDGREN | 3117 | 00034609 | May.26, 2018 | May.25, 2019 |
| Power Amplifier | rflight | NTWPA- 2560100 | 17063183 | Oct.18, 2018 | Oct.17, 2019 |
| Broadband High Gain Horn Antenna | SCHWARZBECK | BBHA 9120 J | 00073 | Mar.19, 2018 | Mar.18, 2020 |

TEST EQUIPMENT OF PFMF TEST

| Description | Manufacturer | Model | Identifier | Cal. Date | Cal. Due |
|-------------|--------------|-------|------------|-------------|--------------|
| PFMF system | HTEC | HPFMF | 161701 | Aug.28 2018 | Aug.27, 2019 |

7. TEST ITEMS AND THE RESULTS

| Test item | Test Requirement | Test Method | Class/Severity | Result |
|---|------------------|---------------|--|--------|
| CONDUCTED EMISSION | EN 55015 | EN 55015 | 0.009MHz -30MHz | N/A |
| RADIATED EMISSION | EN 55015 | EN 55015 | 30MHz -300MHz | Pass |
| RADIATED ELECTROMAGNETIC DISTURBANCE | EN 55015 | EN 55015 | 0.009MHz -30MHz | N/A |
| Harmonic current emission | EN 61000-3-2 | EN 61000-3-2 | Class C | N/A |
| Voltage fluctuations & flicker | EN 61000-3-3 | EN 61000-3-3 | §5 of EN 61000-3-3 | N/A |
| Electrostatic Discharge Immunity | EN 61547 | EN 61000-4-2 | ± 8.0 kV (Air Discharge) ± 4.0 kV (Contact Discharge) ± 4.0 kV (Indirect Discharge) | Pass |
| Radiated RF Electromagnetic | EN 61547 | EN 61000-4-3 | 3V/m with 80% AM. 1kHz Modulation. | Pass |
| Electrical fast transient/burst Immunity | EN 61547 | EN 61000-4-4 | +/- 1kV for Power Supply Lines | N/A |
| SURGE IMMUNITY | EN 61547 | EN 61000-4-5 | >25W +/-1kV (Line to Line) +/-2kV (Line to Ground) ≤25W +/-0.5kV (Line to Line) +/-1kV (Line to Ground) | N/A |
| Immunity to Conducted Disturbances Induced by RF fields | EN 61547 | EN 61000-4-6 | 3V with 80% AM. 1 kHz Modulation | N/A |
| Power Frequency Magnetic Fields | EN 61547 | EN61000-4-8 | 50/60 Hz, 3A/m | Pass |
| Voltage dips and short interruptions immunity | EN 61547 | EN 61000-4-11 | PHASE ANGLE 0, 45, 90, 135, 180, 225, 270, 315 degrees | N/A |

Note: N/A means not applicable.

8. EN 55015 RADIATED EMISSION TEST

8.1. LIMITS OF RADIATED DISTURBANCES

AT 10M DISTANCES

| Frequency (MHz) | Distance (m) | Maximum Field Strength Limit (dBuV/m Q.P.) |
|-----------------|--------------|--|
| 30-230 | 10 | 30.00 |
| 230-300 | 10 | 37.00 |

AT 3M DISTANCES

| Frequency (MHz) | Distance (m) | Maximum Field Strength Limit (dBuV/m Q.P.) |
|-----------------|--------------|--|
| 30-230 | 3 | 40.00 |
| 230-300 | 3 | 47.00 |

Note: The lower limit shall apply at the transition frequency.

8.2. BLOCK DIAGRAM OF TEST SETUP

System Diagram of Connections between EUT and Simulators

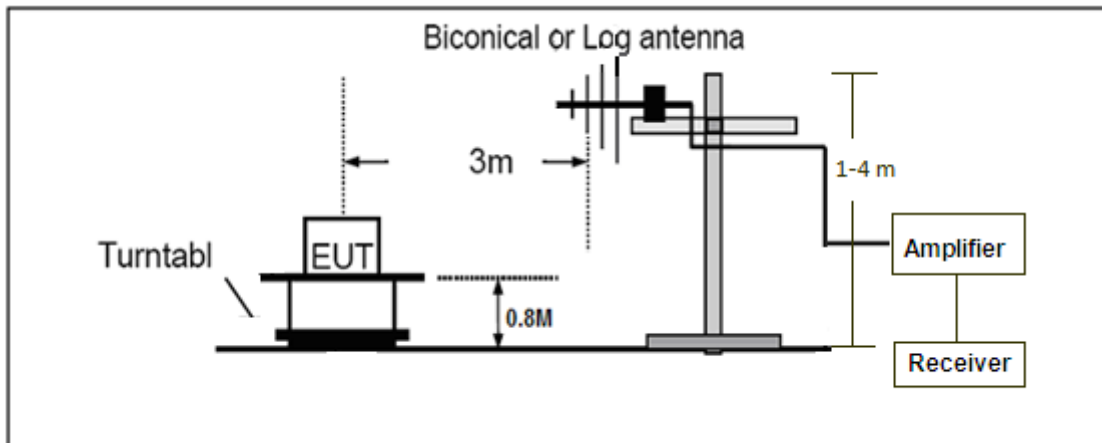

8.3. PROCEDURE OF RADIATED EMISSION TEST

- (1) The equipment was set up as per the test configuration to simulate typical actual usage per the user's manual. When the EUT is a tabletop system, a wooden turntable with a height of 0.8 meters is used which is placed on the ground plane as per EN 55015 (see Test Facility for the dimensions of the ground plane used). When the EUT is a floor-standing equipment, it is placed on the ground plane which has a 3-12 mm non-conductive covering to insulate the EUT from the ground plane.
- (2) Support equipment, if needed, was placed as per EN 55015.
- (3) All I/O cables were positioned to simulate typical actual usage as per EN 55015.
- (4) The EUT was turned on.
- (5) The antenna was placed at 3 meters away from the EUT as stated in EN 55015. The antenna connected to the Analyzer via a cable and at times a pre-amplifier would be used.
- (6) The Analyzer / Receiver quickly scanned from 30MHz to 1000MHz. The EUT test program was started. Emissions were scanned and measured rotating the EUT to 360 degrees and positioning the antenna 1 to 4 meters above the ground plane, in both the vertical and the horizontal polarization, to maximize the emission reading level.
- (7) The test mode(s) were scanned during the test:
- (8) Recorded at least the six highest emissions. Emission frequency, amplitude, antenna position, polarization and turntable position were recorded into a computer in which correction factors were used to calculate the emission level and compare reading to the applicable limit and Q.P./Peak reading is presented.

8.4. TEST RESULT OF RADIATED EMISSION TEST

Radiated Emission Test at 3m Distance-Horizontal

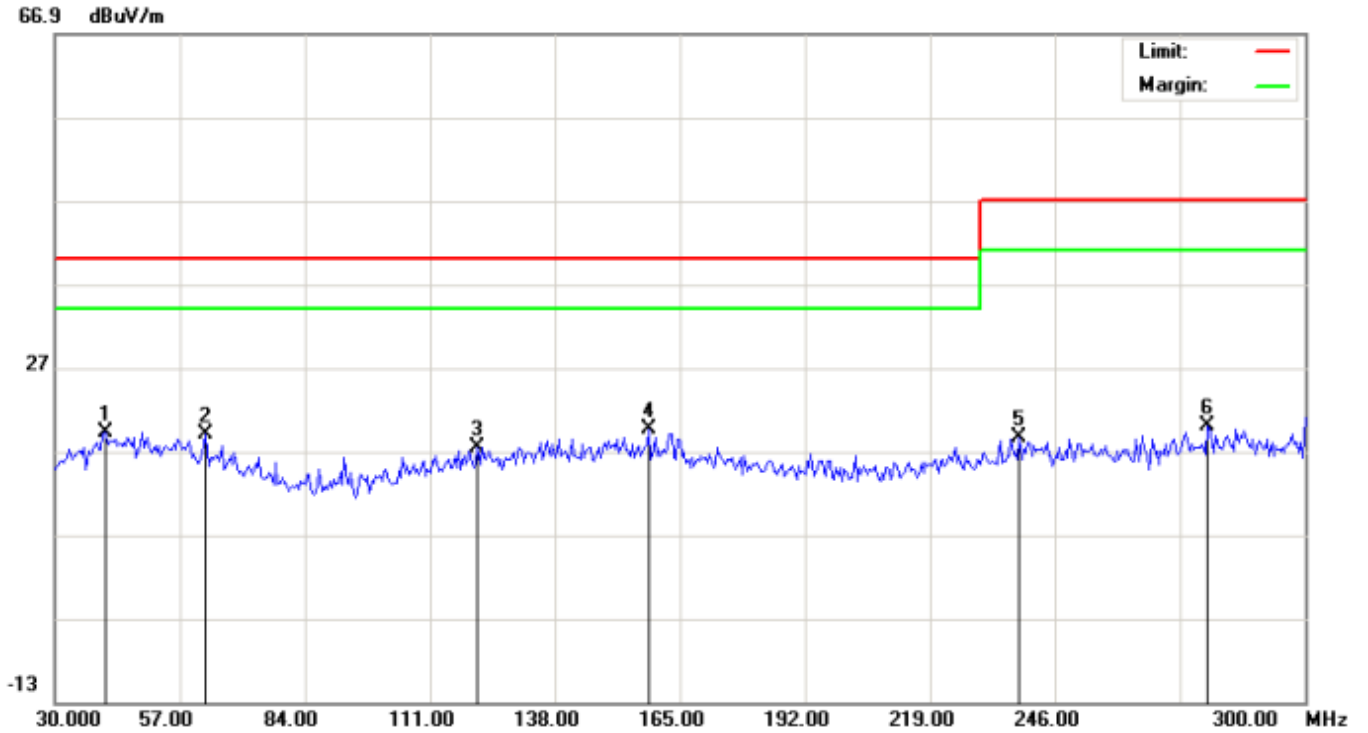

| No. | Mk | Freq. | Reading | Factor | Measurement | Limit | Over | Detector |
|-----|----|----------|---------|--------|-------------|--------|--------|----------|
| | | MHz | dBuV | dB/m | dBuV/m | dBuV/m | dB | |
| 1 | | 40.8000 | -0.81 | 20.06 | 19.25 | 40.00 | -20.75 | peak |
| 2 | | 62.4000 | 0.46 | 18.45 | 18.91 | 40.00 | -21.09 | peak |
| 3 | | 121.3500 | -0.66 | 18.06 | 17.40 | 40.00 | -22.60 | peak |
| 4 | * | 158.2500 | 0.42 | 19.19 | 19.61 | 40.00 | -20.39 | peak |
| 5 | | 238.3500 | 0.15 | 18.54 | 18.69 | 47.00 | -28.31 | peak |
| 6 | | 278.8500 | 0.18 | 19.85 | 20.03 | 47.00 | -26.97 | peak |

RESULT: PASS

Radiated Emission Test at 3m Distance-Vertical

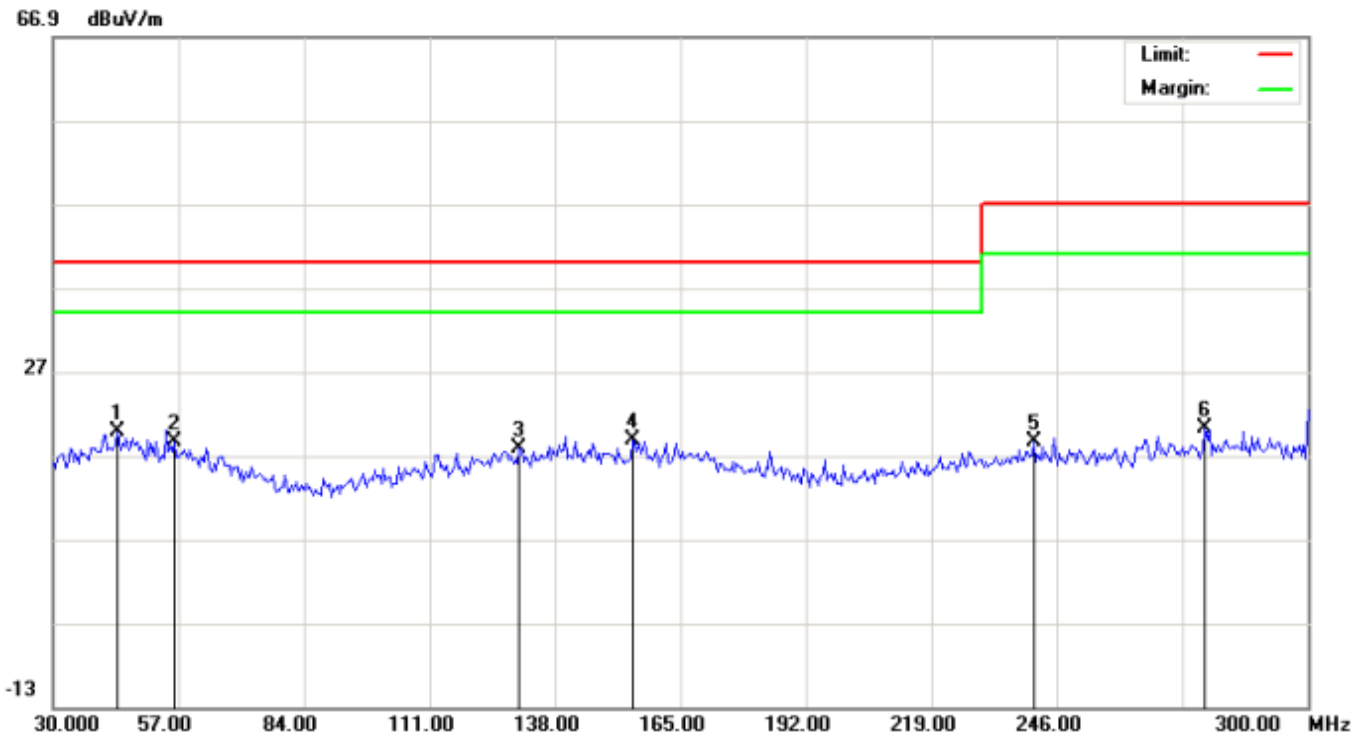

| No. | Mk | Freq. | Reading | Factor | Measurement | Limit | Over | Detector |
|-----|----|----------|---------|--------|-------------|--------|--------|----------|
| | | MHz | dBuV | dB/m | dBuV/m | dBuV/m | dB | |
| 1 | * | 43.9500 | -0.10 | 19.95 | 19.85 | 40.00 | -20.15 | peak |
| 2 | | 56.1000 | -0.61 | 19.21 | 18.60 | 40.00 | -21.40 | peak |
| 3 | | 130.3500 | -0.91 | 18.62 | 17.71 | 40.00 | -22.29 | peak |
| 4 | | 154.6500 | -0.47 | 19.20 | 18.73 | 40.00 | -21.27 | peak |
| 5 | | 241.0500 | -0.04 | 18.64 | 18.60 | 47.00 | -28.40 | peak |
| 6 | | 277.9500 | 0.39 | 19.77 | 20.16 | 47.00 | -26.84 | peak |

RESULT: PASS

Note:

Measurement (dBuV/m)=Reading(dBuV)+Factor(dB/m)

Factor(dB/m)=Antenna Factor(dB/m)+Cable loss(dB)+Attenuation(dB)for Attenuator

Over= Measurement-Limit

9. EN 55015 RADIATED ELECTROMAGNETIC DISTURBANCE TEST

9.1. LIMITS OF RADIATED ELECTROMAGNETIC DISTURBANCE IN THE RANGE 9 KHZ TO 30 MHZ

| Frequency Range | Limits for Loop Diameter dB(uA)* | | |
|-----------------|-------------------------------------|-------------|------------|
| | 2m | 3m | 4m |
| 9 KHz-70 KHz | 88* | 81* | 75* |
| 70 KHz-150 KHz | 88 to 58** | 81 to 51** | 75 to 45** |
| 150 kHz-3.0 MHz | 58 to 22** | 51 to 15** | 45 to 9** |
| 3.0 MHz-30 MHz | 22*** | 15 to 16*** | 9 to 12*** |

Note:

*At the transition frequency, the lower limit applies.

** Decreasing linearly with the logarithm of the frequency. For electrode less lamps and luminaries, the limit in the frequency range of 2.2 MHz to 3.0 MHz is 58 dB(uA) for 2m, 51 dB(uA) for 3m and 45 dB(uA) for 4m loop diameter.

*** Increasing linearly with the logarithm of the frequency.

9.2. BLOCK DIAGRAM OF TEST SETUP

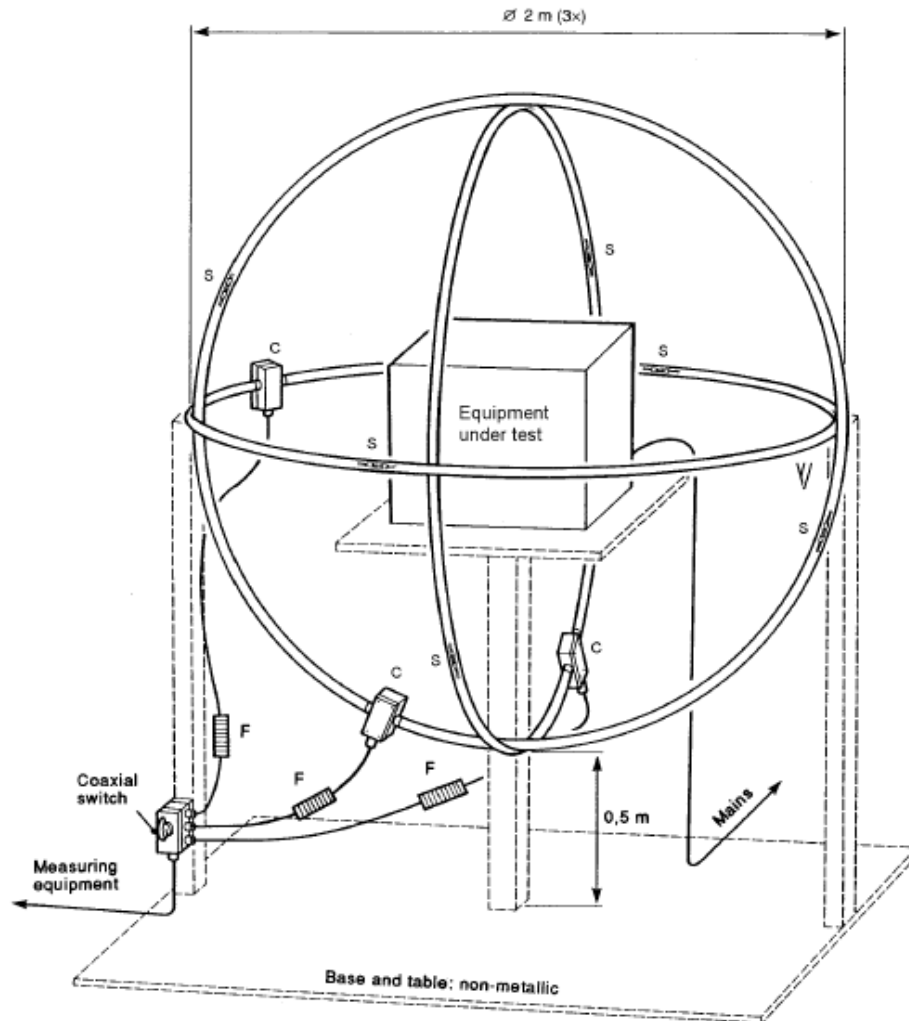

9.3. TEST PROCEDURE

The magnetic component shall be measured by means of a loop antenna as described in EN 55015. The lighting equipment shall be placed in the centre of the antenna, and the position is not critical.

The test object was operated at its upper limit of its rated voltage and its rated frequency. The induced current in the loop antenna is measured by means of a current probe(1V/A) and the CISPR measuring receiver. By means of a coaxial switch the three field directions can be measured in sequence. Each value shall fulfill the requirements given.

9.4. RESULT

Note: Owing to the operating frequency of EUT is less than 100Hz, so test is not applicable.

10. EN 61000-4-2 ESD IMMUNITY TEST

ELECTROSTATIC DISCHARGE (ESD) IMMUNITY TEST

| | |
|-------------------------|---|
| Port | Enclosure |
| Basic Standard | EN 61000-4-2 |
| Test Level | ± 8.0 kV (Air Discharge) ± 4.0 kV (Contact Discharge) ± 4.0 kV (Indirect Discharge) |
| Standard require | B |
| Tester | Erik |
| Temperature | 24 °C |
| Humidity | 53% |

10.1. BLOCK DIAGRAM OF TEST SETUP

(The 470 k ohm resistors are installed per standard requirement)

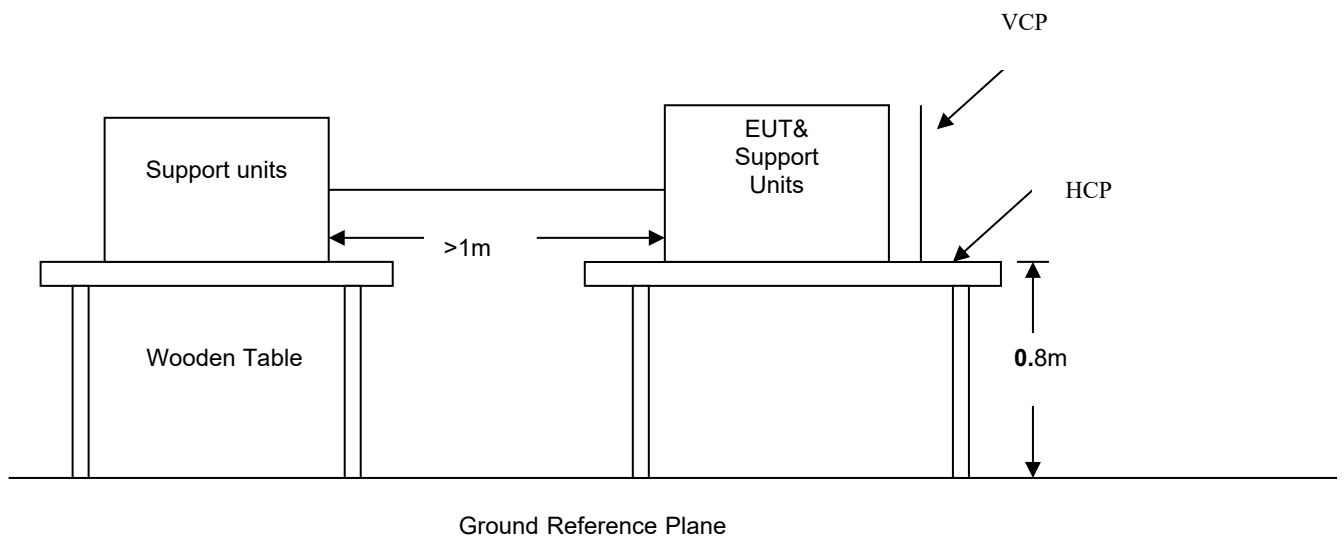

10.2. TEST PROCEDURE

The EUT was located 0.1 m minimum from all side of the HCP.

The support units were located 1 m minimum away from the EUT.

EUT worked with resistance load, and make sure EUT worked normally.

Activates the communication function if the EUT with such port(s).

As per the requirement of EN 61547: Contact discharge is the preferred test method, twenty discharges (10 with positive and 10 with negative polarity) shall be applied on each accessible metallic part of the enclosure, terminals are excluded. Air discharges shall be used where contact discharges cannot be applied. Discharges shall be applied on the horizontal or vertical coupling planes as specified in EN 61000-4-2.

The following test condition was followed during the tests.

Note: As per the A2 to EN 61000-4-2, a bleed resistor cable is connected between the EUT and HCP during the test.

The electrostatic discharges were applied as follows:

| Voltage | Coupling | Test Performance | Result |
|---------|--------------------------------|------------------|--------|
| ±4kV | Contact Discharge | No function loss | A |
| ±4kV | Indirect Discharge HCP (Front) | No function loss | A |
| ±4kV | Indirect Discharge HCP (Left) | No function loss | A |
| ±4kV | Indirect Discharge HCP (Back) | No function loss | A |
| ±4kV | Indirect Discharge HCP (Right) | No function loss | A |
| ±4kV | Indirect Discharge VCP (Front) | No function loss | A |
| ±4kV | Indirect Discharge VCP (Left) | No function loss | A |
| ±4kV | Indirect Discharge VCP (Back) | No function loss | A |
| ±4kV | Indirect Discharge VCP (Right) | No function loss | A |
| ±8kV | Air Discharge | No function loss | A |

10.3. PERFORMANCE & RESULT

| | |
|--------------------|--|
| Criteria A: | The apparatus continues to operate as intended. No degradation of performance or loss of function is allowed below a performance level specified by the manufacturer, when the apparatus is used as intended. In some cases the performance level may be replaced by a permissible loss of performance. |
| Criteria B: | The apparatus continues to operate as intended after the test. No degradation of performance or loss of function is allowed below a performance level specified by the manufacturer, when the apparatus is used as intended. In some cases the performance level may be replaced by a permissible loss of performance. During the test, degradation of performance is however allowed. |
| Criteria C: | Temporary loss of function is allowed, provided the functions self recoverable or can be restored by the operation of controls. |

PASS

FAIL

11. EN 61000-4-3 RS IMMUNITY TEST

RADIATED ELECTROMAGNETIC FIELD IMMUNITY TEST

| | |
|-------------------------|------------------------------------|
| Port | Enclosure |
| Basic Standard | EN 61000-4-3 |
| Test Level: | 3V/m with 80% AM. 1kHz Modulation. |
| Standard require | A |
| Tester | Erik |
| Temperature | 23°C |
| Humidity | 54% |

11.1. BLOCK DIAGRAM OF TEST SETUP

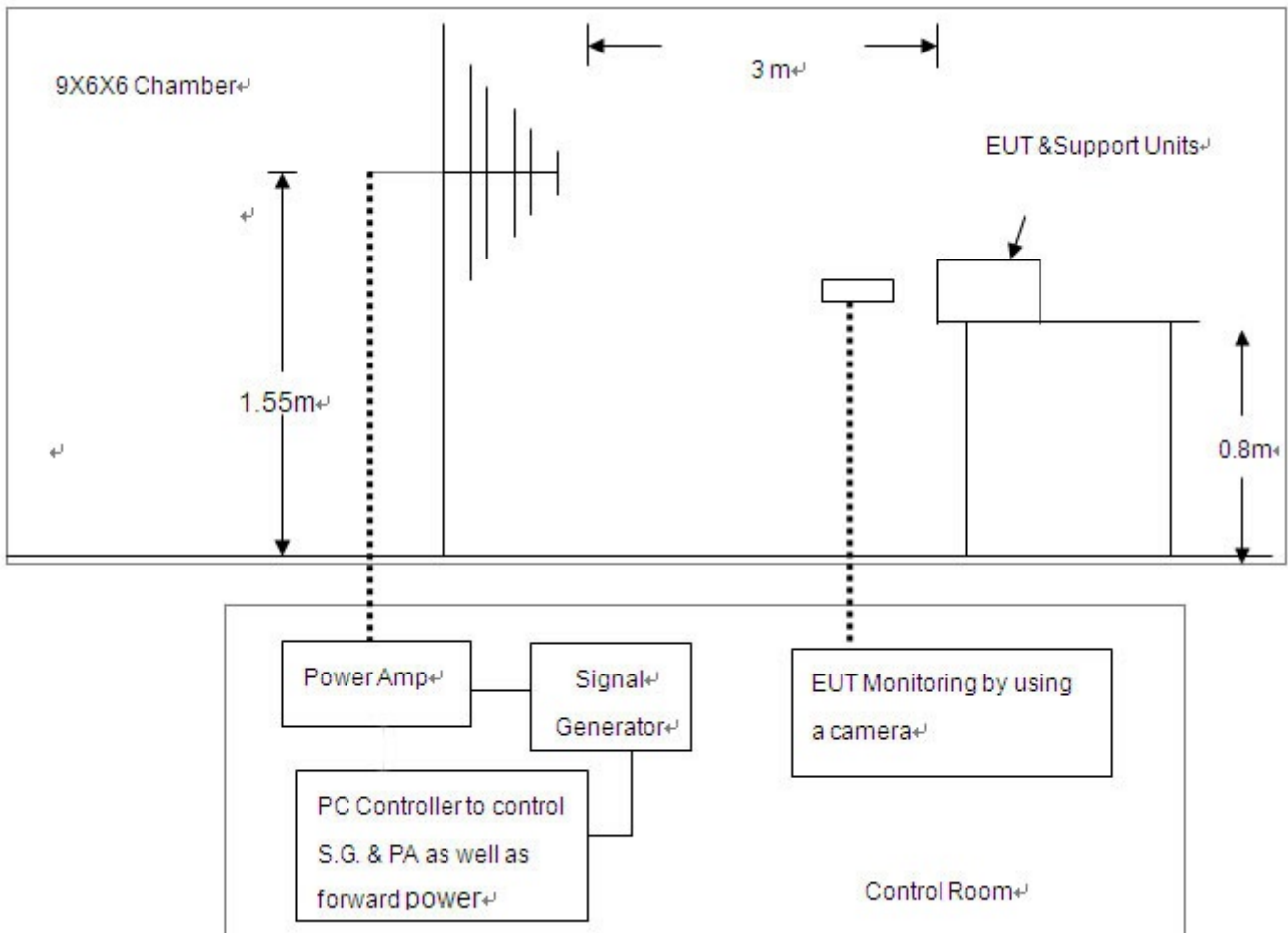

11.2. TEST PROCEDURE

The EUT was located at the edge of supporting table keep 3 meter away from transmitting antenna, it just the calibrated square area of field uniformity. The support units were located outside of the uniformity area, but the cable(s) connected with EUT were exposed to the calibrated field as per EN 61000-4-3.

EUT worked with resistance load, and make sure EUT worked normally.

Setting the testing parameters of RS test software per EN 61000-4-3.

Performing the test at each side of with specified level (3V/m) at 1% steps and test frequency from 80MHz to 1000MHz

Recording the test result in following table.

EN 61000-4-3 Final test conditions:

Test level: 3V/m

Steps: 1 % of fundamental

Dwell Time: 1 sec

| Range (MHz) | Field | Modulation | Polarity | Position | Test Performance | Result |
|-------------|-------|------------|----------|----------|------------------|--------|
| 80-1000 | 3V/m | AM | H | Front | No function loss | A |
| 80-1000 | 3V/m | AM | H | Left | No function loss | A |
| 80-1000 | 3V/m | AM | H | Back | No function loss | A |
| 80-1000 | 3V/m | AM | H | Right | No function loss | A |
| 80-1000 | 3V/m | AM | V | Front | No function loss | A |
| 80-1000 | 3V/m | AM | V | Left | No function loss | A |
| 80-1000 | 3V/m | AM | V | Back | No function loss | A |
| 80-1000 | 3V/m | AM | V | Right | No function loss | A |

11.3. PERFORMANCE & RESULT

| | |
|--------------------|--|
| Criteria A: | The apparatus continues to operate as intended. No degradation of performance or loss of function is allowed below a performance level specified by the manufacturer, when the apparatus is used as intended. In some cases the performance level may be replaced by a permissible loss of performance. |
| Criteria B: | The apparatus continues to operate as intended after the test. No degradation of performance or loss of function is allowed below a performance level specified by the manufacturer, when the apparatus is used as intended. In some cases the performance level may be replaced by a permissible loss of performance. During the test, degradation of performance is however allowed. |
| Criteria C: | Temporary loss of function is allowed, provided the functions self recoverable or can be restored by the operation of controls. |

PASS

FAIL

12. EN 61000-4-8 PFMF TEST

POWER FREQUENCY MAGNETIC FIELDS IMMUNITY TEST

| | |
|-------------------------|----------------|
| Port | Enclosure |
| Basic Standard | EN 61000-4-8 |
| Requirements | 50/60 Hz, 3A/m |
| Standard require | A |
| Tester | Erik |
| Temperature | 25 °C |
| Humidity | 55% |

12.1. BLOCK DIAGRAM OF TEST SETUP

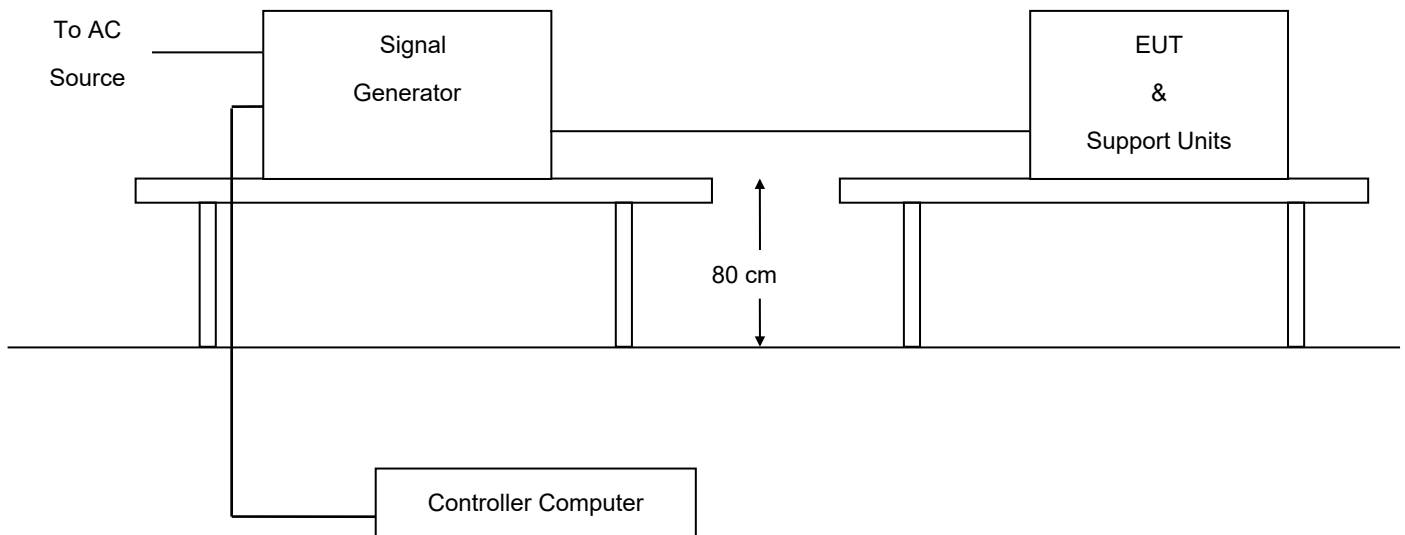

12.2. TEST PROCEDURE

The EUT shall be subjected to the test magnetic field by using the induction coil of standard dimensions (1m × 1m). The induction coil shall then be rotated by 90° in order to expose the EUT to the test field with different orientations.

Test Conditions:

| Frequency | Polarity | Level | Test Performance | Performance Result |
|-----------|----------|-------|------------------|--------------------|
| 50 Hz | X | 3 A/m | No function loss | A |
| 50 Hz | Y | 3 A/m | No function loss | A |
| 50 Hz | Z | 3 A/m | No function loss | A |

12.3. PERFORMANCE & RESULT

| | |
|--------------------|--|
| Criteria A: | The apparatus continues to operate as intended. No degradation of performance or loss of function is allowed below a performance level specified by the manufacturer, when the apparatus is used as intended. In some cases the performance level may be replaced by a permissible loss of performance. |
| Criteria B: | The apparatus continues to operate as intended after the test. No degradation of performance or loss of function is allowed below a performance level specified by the manufacturer, when the apparatus is used as intended. In some cases the performance level may be replaced by a permissible loss of performance. During the test, degradation of performance is however allowed. |
| Criteria C: | Temporary loss of function is allowed, provided the functions self recoverable or can be restored by the operation of controls. |

PASS

FAIL

APPENDIX A: PHOTOGRAPHS OF TEST SETUP

EN 55015 RADIATED EMISSION TEST SETUP

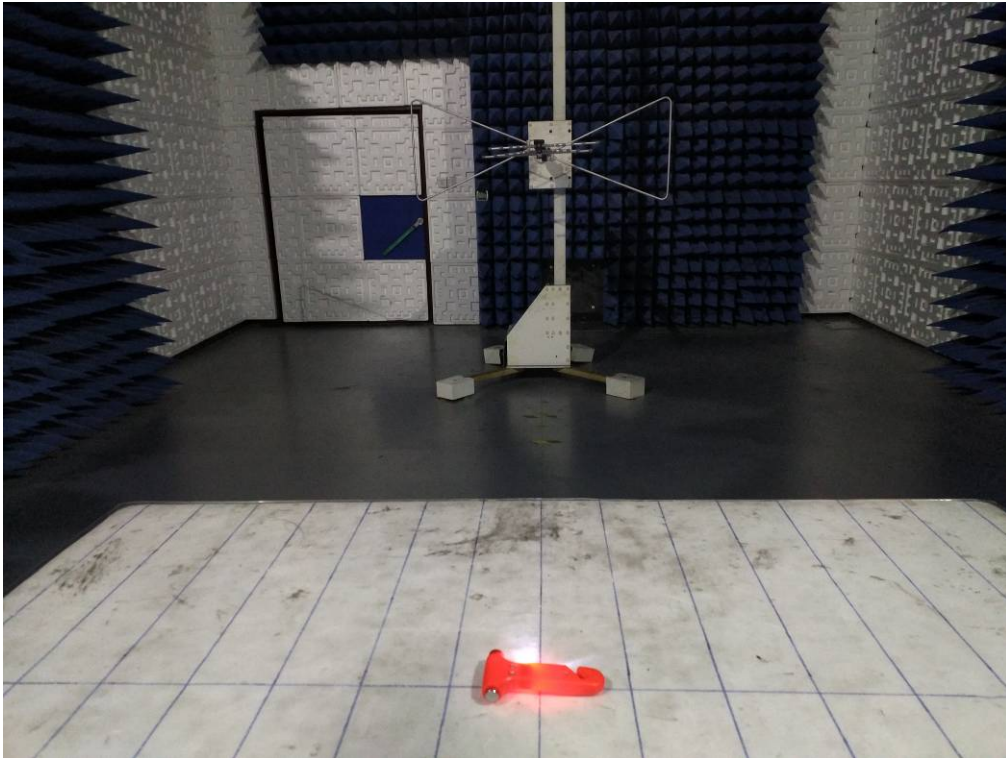

EN 61000-4-2 ESD IMMUNITY TEST SETUP

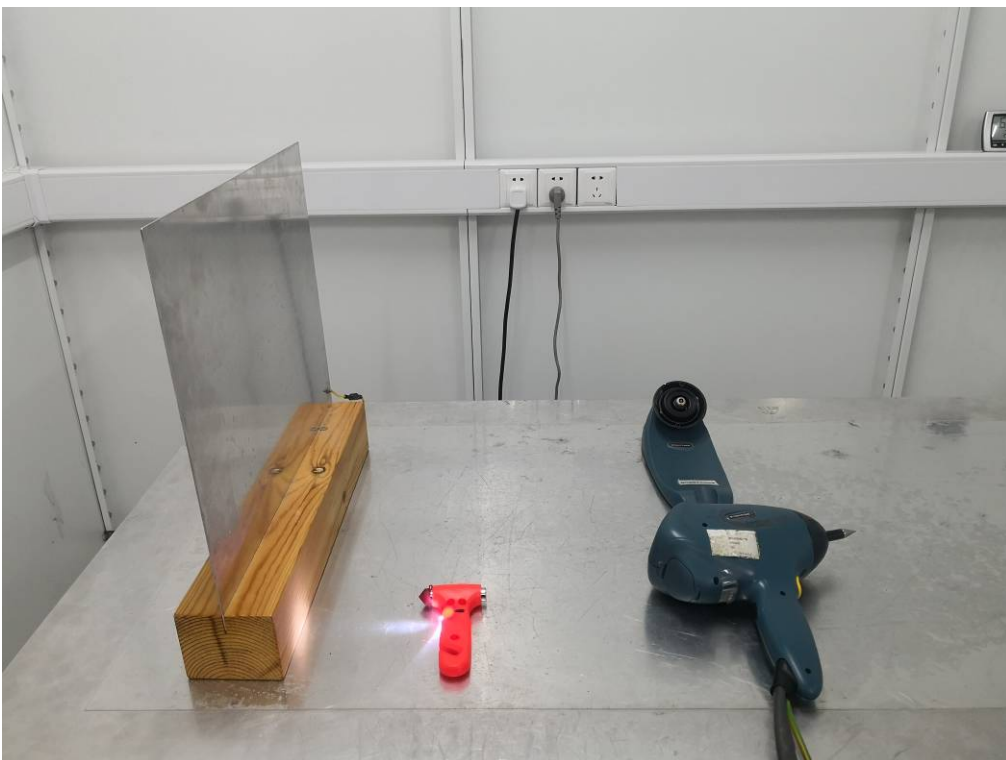

EN 61000-4-3 RS IMMUNITY TEST SETUP

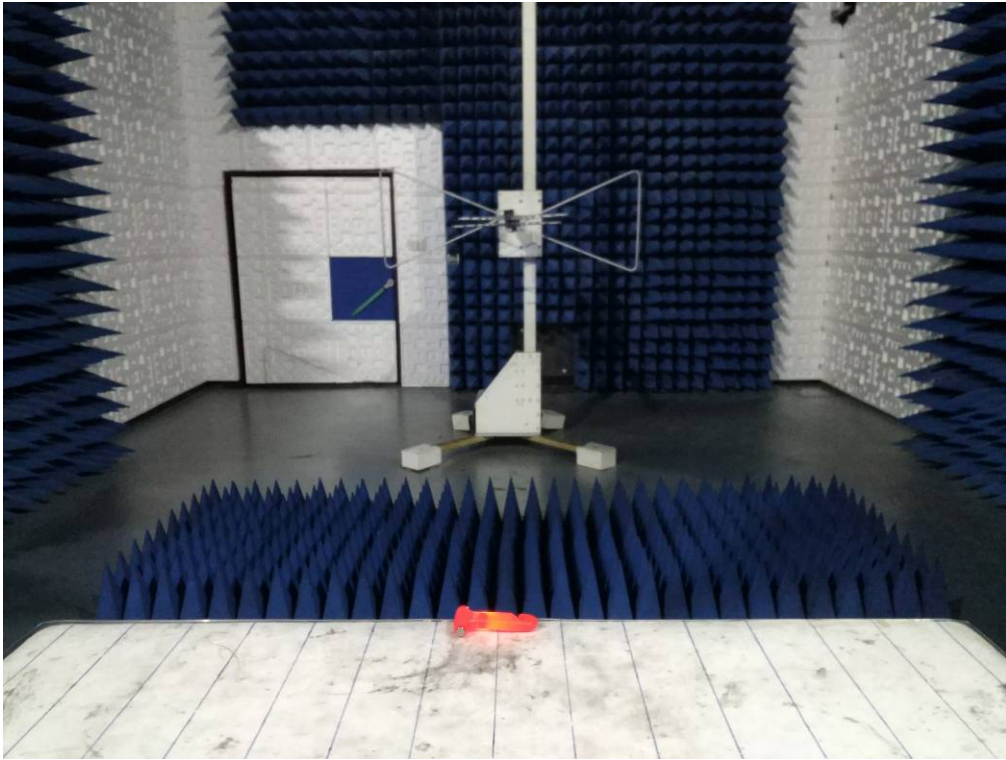

EN 61000-4-8 PFMF IMMUNITY TEST SETUP

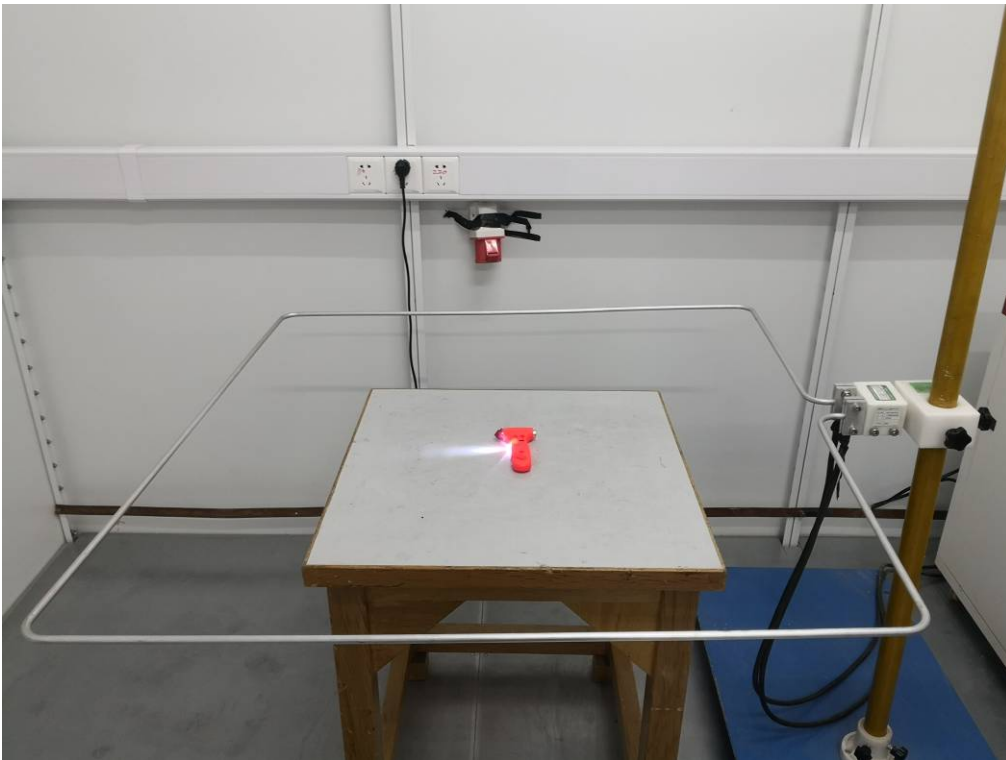

APPENDIX B: PHOTOGRAPHS OF EUT

ALL VIEW OF EUT

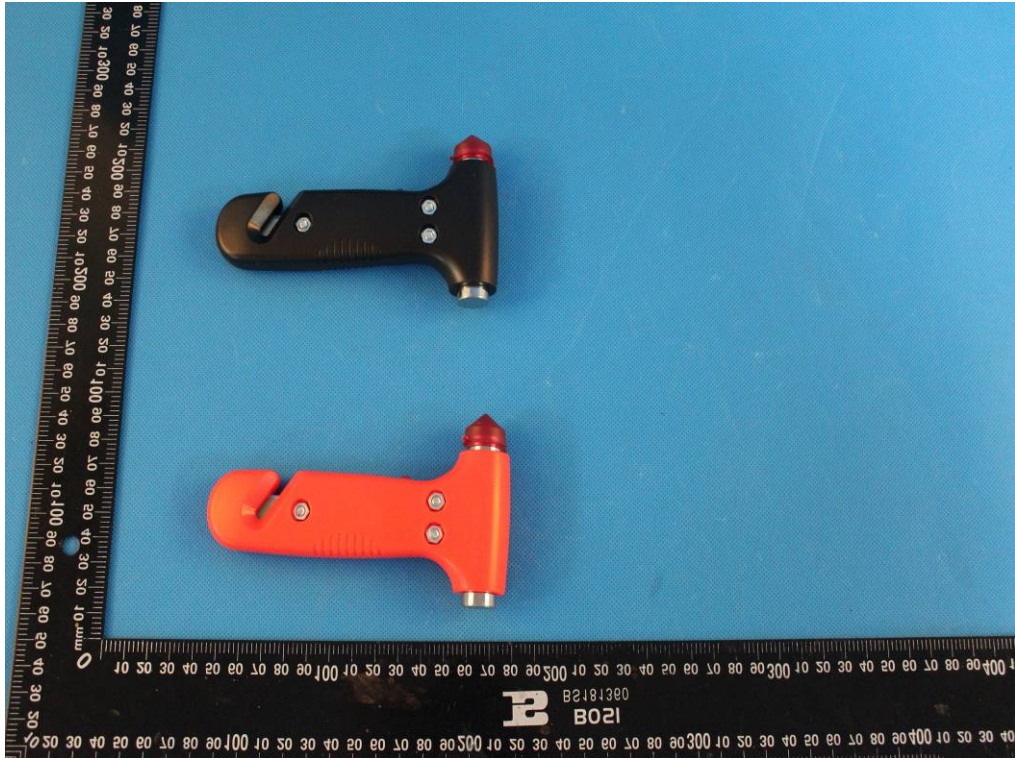

TOP VIEW OF EUT



BOTTOM VIEW OF EUT

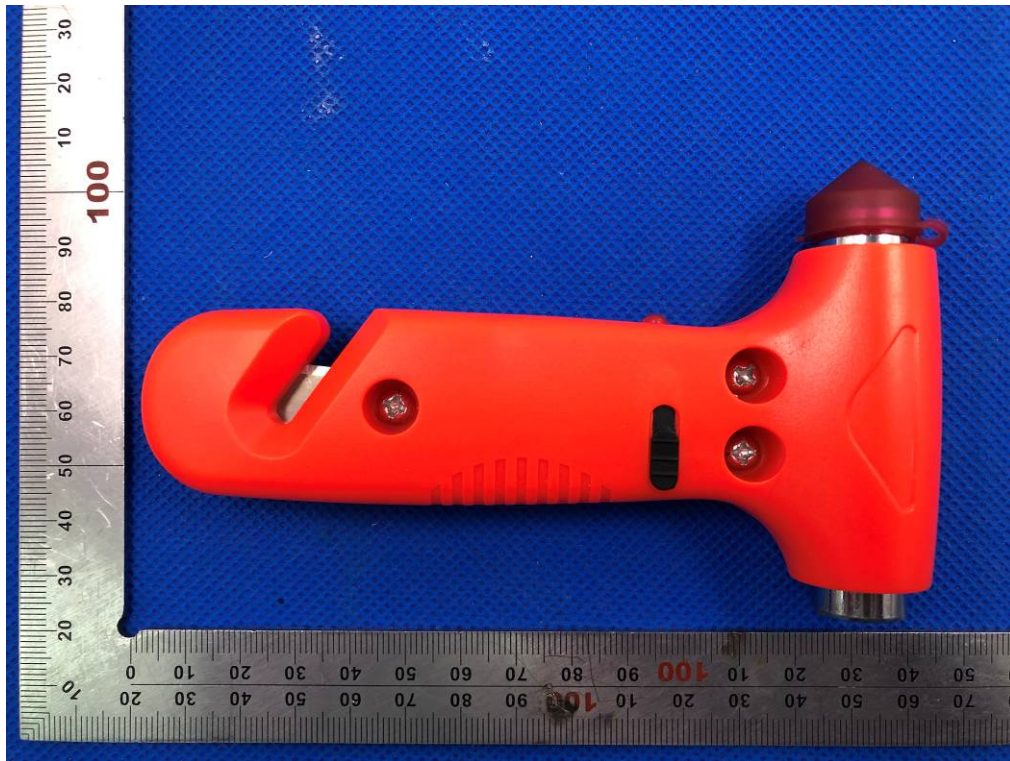

FRONT VIEW OF EUT

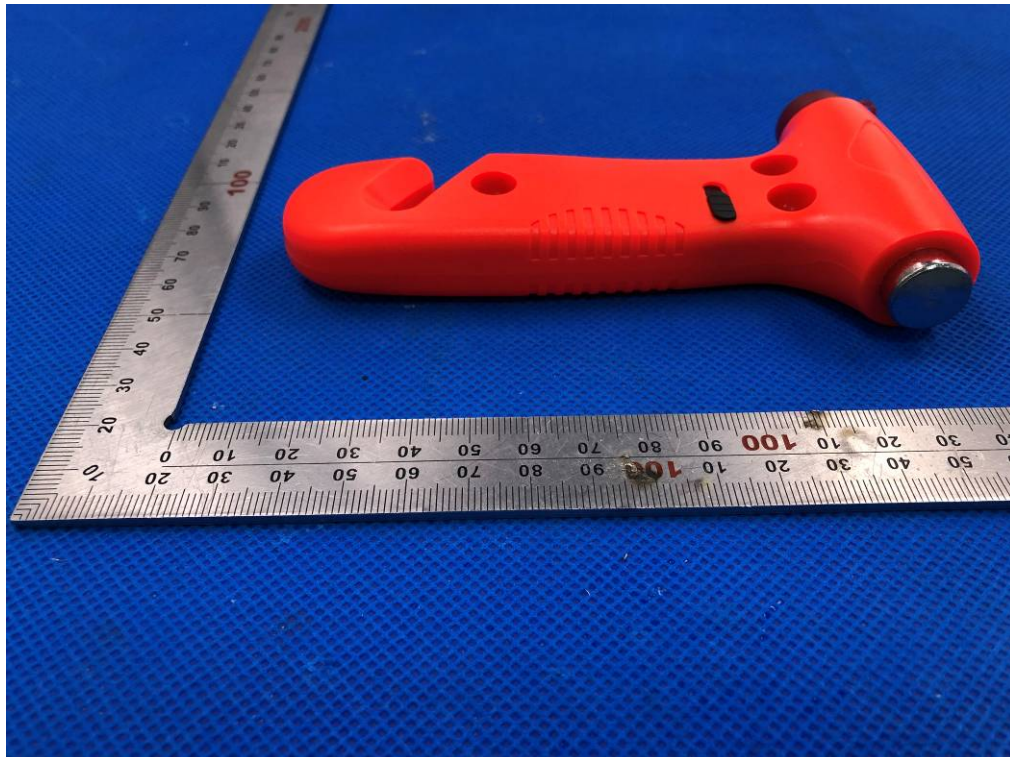

BACK VIEW OF EUT

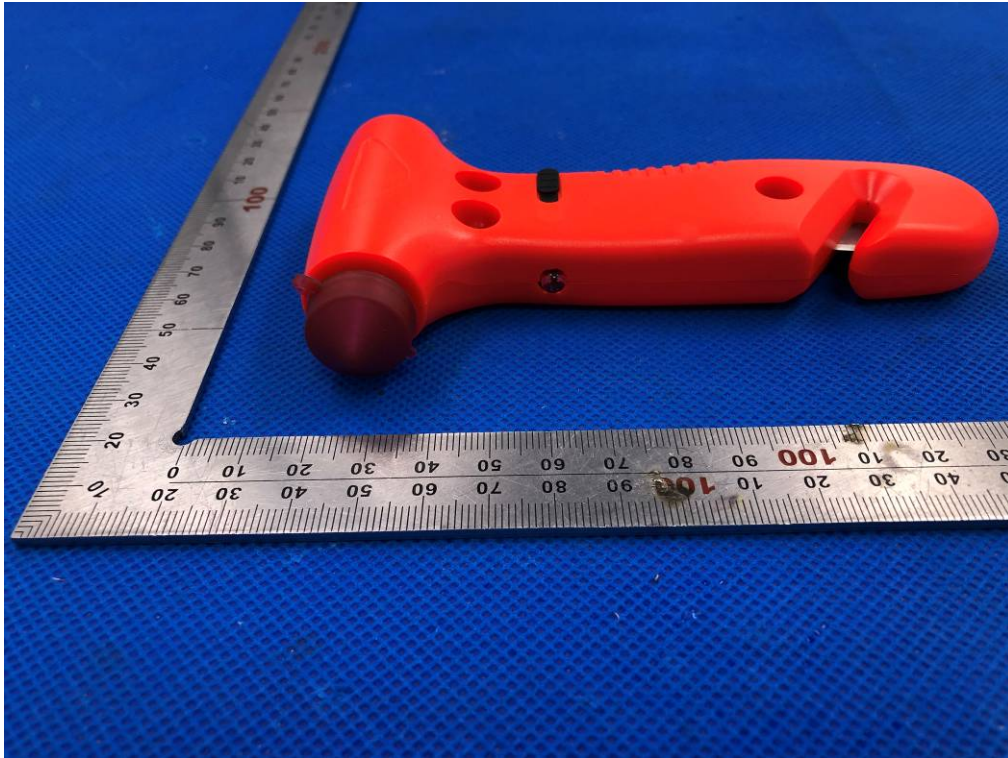

LEFT VIEW OF EUT

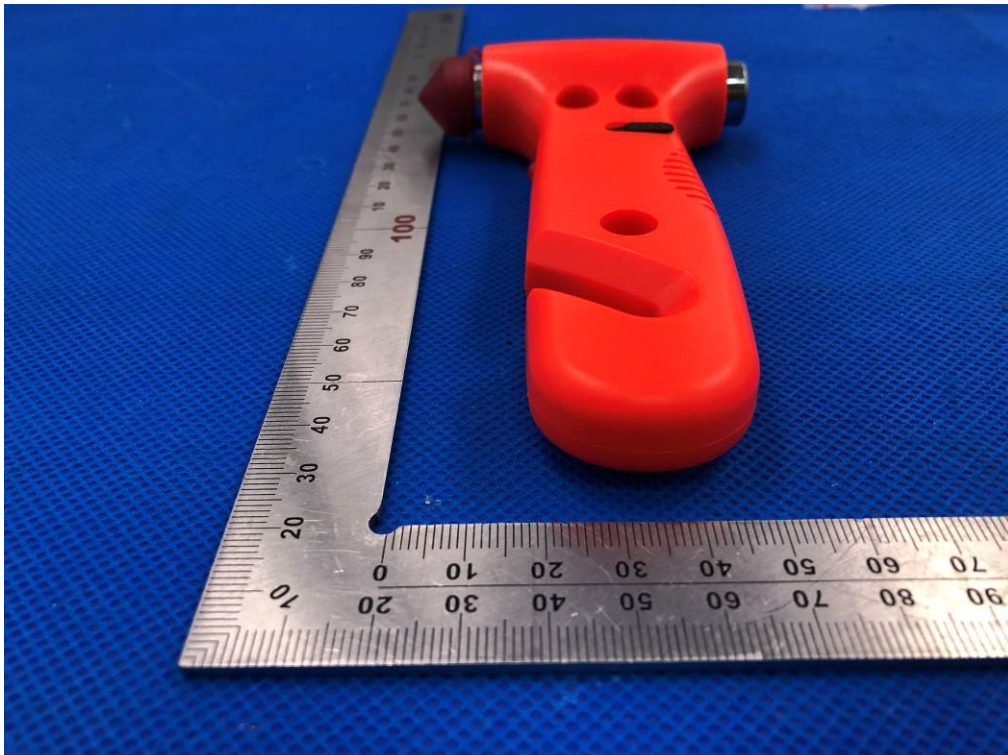

RIGHT VIEW OF EUT



OPEN VIEW OF EUT



-----END OF REPORT-----